

No. STSE-CU7061A

<Cat.No.070518>

SPECIFICATIONS FOR NICHIA UV LED

MODEL : **NSPU510CS**

NICHIA CORPORATION

1.SPECIFICATIONS

(1) Absolute Maximum Ratings (Ta=25°C)

Item	Symbol	Absolute Maximum Rating	Unit
Forward Current	IF	20	mA
Pulse Forward Current	IFP	80	mA
Allowable Reverse Current	IR	85	mA
Power Dissipation	PD	80	mW
Operating Temperature	Topr	-30 ~ + 85	°C
Storage Temperature	Tstg	-40 ~ +100	°C
Soldering Temperature	Tsld	265°C for 10sec.	

IFP Conditions : Pulse Width \leq 10msec. and Duty \leq 1/10

(2) Initial Electrical/Optical Characteristics (Ta=25°C)

Item	Symbol	Condition	Min.	Typ.	Max.	Unit
Forward Voltage	VF	IF=15[mA]	-	(3.6)	4.0	V
Peak Wavelength	Rank Ub λ_P	IF=15[mA]	370	(375)	380	nm
Spectrum Half Width	$\Delta\lambda$	IF=15[mA]	-	(15)	-	nm
Optical Power Output	Rank 7	PO	4800	-	6800	μ W
	Rank 8	PO	6800	-	9600	μ W
	Rank 9	PO	9600	-	13600	μ W

* Optical Power Output Measurement allowance is \pm 10%.

** Peak Wavelength Measurement allowance is \pm 3nm.

*** One delivery will include up to three different ranks of the products.
The quantity-ratio of the three ranks is decided by Nichia.

2.INITIAL OPTICAL/ELECTRICAL CHARACTERISTICS

Please refer to figure's page.

3.OUTLINE DIMENSIONS AND MATERIALS

Please refer to figure's page.

Material as follows ; Resin(Mold) : Epoxy Resin (over Diffusion)
Leadframe : Ag plating Copper Alloy

4.PACKAGING

- The LEDs are packed in cardboard boxes after packaging in anti-electrostatic bags.

Please refer to figure's page.

The label on the minimum packing unit shows ; Part Number, Lot Number, Ranking, Quantity

- In order to protect the LEDs from mechanical shock, we pack them in cardboard boxes for transportation.
- The LEDs may be damaged if the boxes are dropped or receive a strong impact against them, so precautions must be taken to prevent any damage.
- The boxes are not water resistant and therefore must be kept away from water and moisture.
- When the LEDs are transported, we recommend that you use the same packing method as Nichia.

5.LOT NUMBER

The first six digits number shows **lot number**.

The lot number is composed of the following characters;

○□×××× - △■

○ - Year (6 for 2006, 7 for 2007)

□ - Month (1 for Jan., 9 for Sep., A for Oct., B for Nov.)

×××× - Nichia's Product Number

△ - Ranking by Wavelength

■ - Ranking by Optical Power Output

6.RELIABILITY

(1) TEST ITEMS AND RESULTS

Test Item	Standard Test Method	Test Conditions	Note	Number of Damaged
Resistance to Soldering Heat	JEITA ED-4701 300 302	Tsld=260 ± 5°C, 10sec. 3mm from the base of the epoxy bulb	1 time	0/22
Solderability	JEITA ED-4701 300 303	Tsld=235 ± 5°C, 5sec. (using flux)	1 time over 95%	0/22
Temperature Cycle	JEITA ED-4701 100 105	-40°C ~ 25°C ~ 100°C ~ 25°C 30min. 5min. 30min. 5min.	100 cycles	0/50
Moisture Resistance Cyclic	JEITA ED-4701 200 203	25°C ~ 65°C ~ -10°C 90%RH 24hrs./1cycle	10 cycles	0/50
High Temperature Storage	JEITA ED-4701 200 201	Ta=100°C	1000hrs.	0/50
Temperature Humidity Storage	JEITA ED-4701 100 103	Ta=60°C, RH=90%	1000hrs.	0/50
Low Temperature Storage	JEITA ED-4701 200 202	Ta=-40°C	1000hrs.	0/50
Steady State Operating Life		Ta=25°C, IF=15mA	1000hrs.	0/50
Steady State Operating Life of High Humidity Heat		60°C, RH=90%, IF=10mA	500hrs.	0/50
Steady State Operating Life of Low Temperature		Ta=-30°C, IF=15mA	1000hrs.	0/50

(2) CRITERIA FOR JUDGING DAMAGE

Item	Symbol	Test Conditions	Criteria for Judgement	
			Min.	Max.
Forward Voltage	V _F	I _F =15mA	-	U.S.L.*) × 1.1
Optical Power Output	P _o	I _F =15mA	L.S.L.***) × 0.5	-

*) U.S.L. : Upper Standard Level

**) L.S.L. : Lower Standard Level

7.CAUTIONS

(1) Cautions

- The devices are UV light LEDs. The LED during operation radiates intense UV light, which precautions must be taken to prevent looking directly at the UV light with unaided eyes. Do not look directly into the UV light or look through the optical system. When there is a possibility to receive the reflection of light, protect by using the UV light protective glasses so that light should not catch one's eye directly.
- The caution label is attached to cardboard box.



(2) Lead Forming

- When forming leads, the leads should be bent at a point at least 3mm from the base of the lead. Do not use the base of the leadframe as a fulcrum during lead forming.
- Lead forming should be done before soldering.
- Do not apply any bending stress to the base of the lead. The stress to the base may damage the LED's characteristics or it may break the LEDs.
- When mounting the LEDs onto a printed circuit board, the holes on the circuit board should be exactly aligned with the leads of the LEDs. If the LEDs are mounted with stress at the leads, it causes deterioration of the lead and this will degrade the LEDs.

(3) Storage

- The LEDs should be stored at 30°C or less and 70%RH or less after being shipped from Nichia and the storage life limits are 3 months. If the LEDs are stored for 3 months or more, they can be stored for a year in a sealed container with a nitrogen atmosphere and moisture absorbent material.
- Nichia LED leadframes are silver plated copper alloy. The silver surface may be affected by environments which contain corrosive substances. Please avoid conditions which may cause the LED to corrode, tarnish or discolor. This corrosion or discoloration may cause difficulty during soldering operations. It is recommended that the LEDs be used as soon as possible.
- Please avoid rapid transitions in ambient temperature, especially, in high humidity environments where condensation can occur.

(4) Static Electricity

- Static electricity or surge voltage damages the LEDs.
It is recommended that a wrist band or an anti-electrostatic glove be used when handling the LEDs.
- All devices, equipment and machinery must be properly grounded. It is recommended that precautions be taken against surge voltage to the equipment that mounts LEDs.
- When inspecting the final products in which LEDs were assembled, it is recommended to check whether the assembled LEDs are damaged by static electricity or not. It is easy to find static-damaged LEDs by a light-on test or a VF test at a lower current (below 1mA is recommended). The LEDs should be used the light detector etc. when testing the light-on. Do not stare into the LEDs when testing.
- Damaged LEDs will show some unusual characteristics such as the forward voltage becomes lower, or the LEDs do not light at the low current.

Criteria : (VF > 2.0V at IF=0.5mA)

(5) Soldering Conditions

- Nichia LED leadframes are silver plated copper alloy. This substance has a low thermal coefficient (easily conducts heat). Careful attention should be paid during soldering.
- Solder the LED no closer than 3mm from the base of the epoxy bulb. Soldering beyond the base of the tie bar is recommended.
- Recommended soldering conditions

Dip Soldering		Hand Soldering	
Pre-Heat	120°C Max.	Temperature	350°C Max.
Pre-Heat Time	60 seconds Max.	Soldering Time	3 seconds Max.
Solder Bath Temperature	260°C Max.	Position	No closer than 3 mm from the base of the epoxy bulb.
Dipping Time	10 seconds Max.		
Dipping Position	No lower than 3 mm from the base of the epoxy bulb.		

- Although the recommended soldering conditions are specified in the above table, dip or hand soldering at the lowest possible temperature is desirable for the LEDs.
- A rapid-rate process is not recommended for cooling the LEDs down from the peak temperature.
- Dip soldering should not be done more than one time.
- Hand soldering should not be done more than one time.
- Do not apply any stress to the lead particularly when heated.
- The LEDs must not be repositioned after soldering.
- After soldering the LEDs, the epoxy bulb should be protected from mechanical shock or vibration until the LEDs return to room temperature.
- Direct soldering onto a PC board should be avoided. Mechanical stress to the resin may be caused from warping of the PC board or from the clinching and cutting of the leadframes. When it is absolutely necessary, the LEDs may be mounted in this fashion but the User will assume responsibility for any problems. Direct soldering should only be done after testing has confirmed that no damage, such as wire bond failure or resin deterioration, will occur. Nichia's LEDs should not be soldered directly to double sided PC boards because the heat will deteriorate the epoxy resin.
- When it is necessary to clamp the LEDs to prevent soldering failure, it is important to minimize the mechanical stress on the LEDs.
- Cut the LED leadframes at room temperature. Cutting the leadframes at high temperatures may cause failure of the LEDs.

(6) Heat Generation

- Thermal design of the end product is of paramount importance. Please consider the heat generation of the LED when making the system design. The coefficient of temperature increase per input electric power is affected by the thermal resistance of the circuit board and density of LED placement on the board, as well as other components. It is necessary to avoid intense heat generation and operate within the maximum ratings given in this specification.
- The operating current should be decided after considering the ambient maximum temperature of LEDs.

(7) Cleaning

- It is recommended that isopropyl alcohol be used as a solvent for cleaning the LEDs. When using other solvents, it should be confirmed beforehand whether the solvents will dissolve the resin or not. Freon solvents should not be used to clean the LEDs because of worldwide regulations.
- Do not clean the LEDs by the ultrasonic. When it is absolutely necessary, the influence of ultrasonic cleaning on the LEDs depends on factors such as ultrasonic power and the assembled condition. Before cleaning, a pre-test should be done to confirm whether any damage to the LEDs will occur.

(8) Safety Guideline for Human Eyes

- In 1993, the International Electric Committee (IEC) issued a standard concerning laser product safety (IEC 825-1). Since then, this standard has been applied for diffused light sources (LEDs) as well as lasers. In 1998 IEC 60825-1 Edition 1.1 evaluated the magnitude of the light source. In 2001 IEC 60825-1 Amendment 2 converted the laser class into 7 classes for end products. Components are excluded from this system. Products which contain visible LEDs are now classified as class 1. Products containing UV LEDs are class 1M. Products containing LEDs can be classified as class 2 in cases where viewing angles are narrow, optical manipulation intensifies the light, and/or the energy emitted is high. For these systems it is recommended to avoid long term exposure. It is also recommended to follow the IEC regulations regarding safety and labeling of products.

(9) Others

- NSPU510CS complies with RoHS Directive.
- This LED also emits visible light. Please take notice of visible light spectrum, in case you use this LED as light source of sensors etc.
- The LEDs described in this brochure are intended to be used for ordinary electronic equipment (such as office equipment, communications equipment, measurement instruments and household appliances). Consult Nichia's sales staff in advance for information on the applications in which exceptional quality and reliability are required, particularly when the failure or malfunction of the LEDs may directly jeopardize life or health (such as for airplanes, aerospace, submersible repeaters, nuclear reactor control systems, automobiles, traffic control equipment, life support systems and safety devices).
- User shall not reverse engineer by disassembling or analysis of the LEDs without having prior written consent from Nichia. When defective LEDs are found, the User shall inform Nichia directly before disassembling or analysis.
- The formal specifications must be exchanged and signed by both parties before large volume purchase begins.
- The appearance and specifications of the product may be modified for improvement without notice.

■ Forward Voltage vs. Forward Current

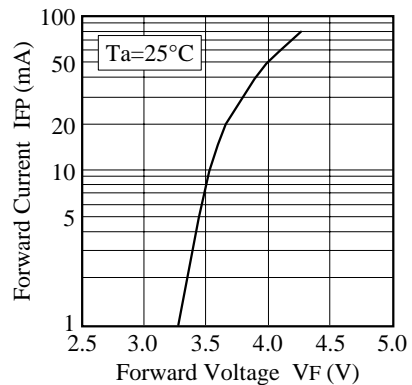

■ Forward Current vs. Relative Power Output

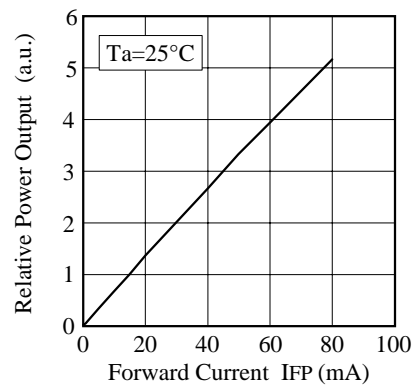

■ Duty Ratio vs. Allowable Forward Current

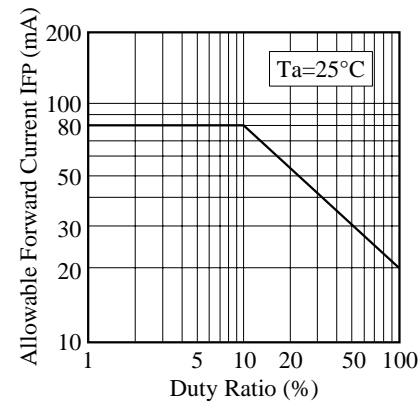

■ Ambient Temperature vs. Forward Voltage

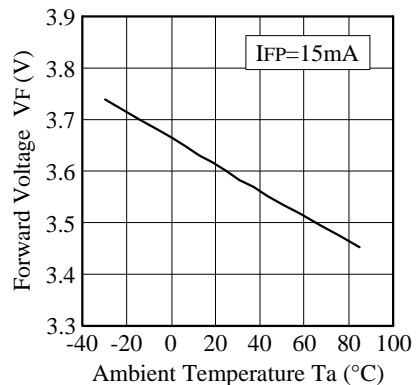

■ Ambient Temperature vs. Relative Power Output

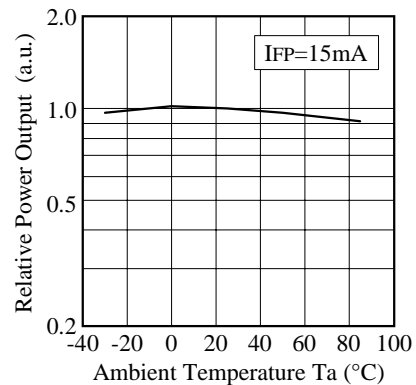

■ Ambient Temperature vs. Allowable Forward Current

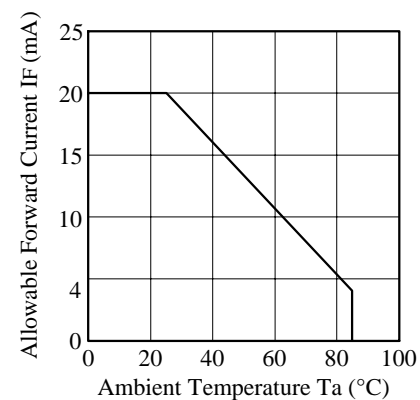

NICHIA CORPORATION	Model	NSPU510CS
	Title	CHARACTERISTICS
	No.	070511764601

■ Forward Current vs. Peak Wavelength

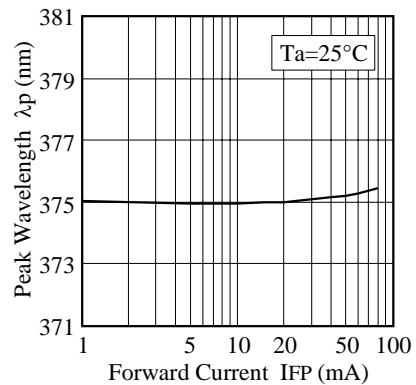

■ Spectrum

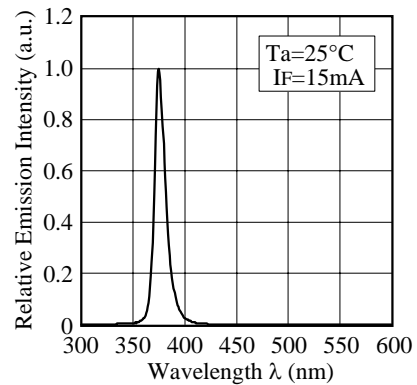

■ Ambient Temperature vs. Peak Wavelength

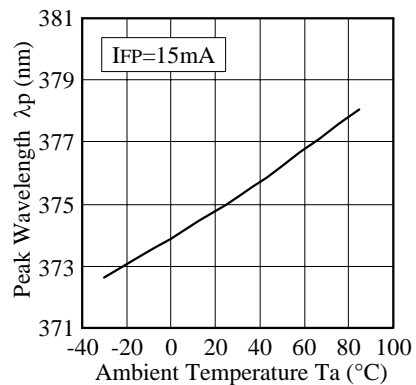

■ Directivity

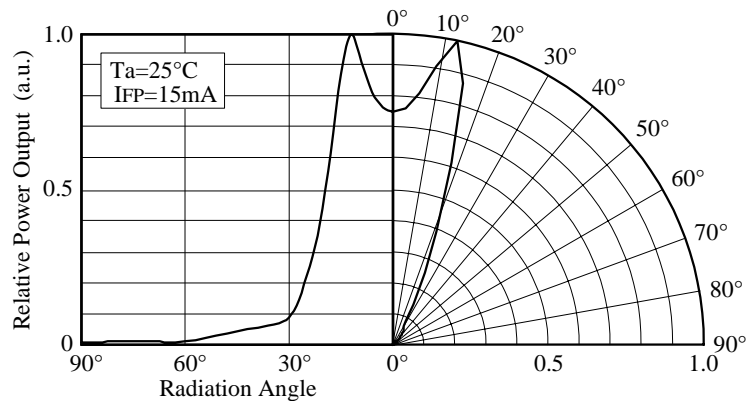

NICHIA CORPORATION	Model	NSPU510CS
	Title	CHARACTERISTICS
	No.	070511764611

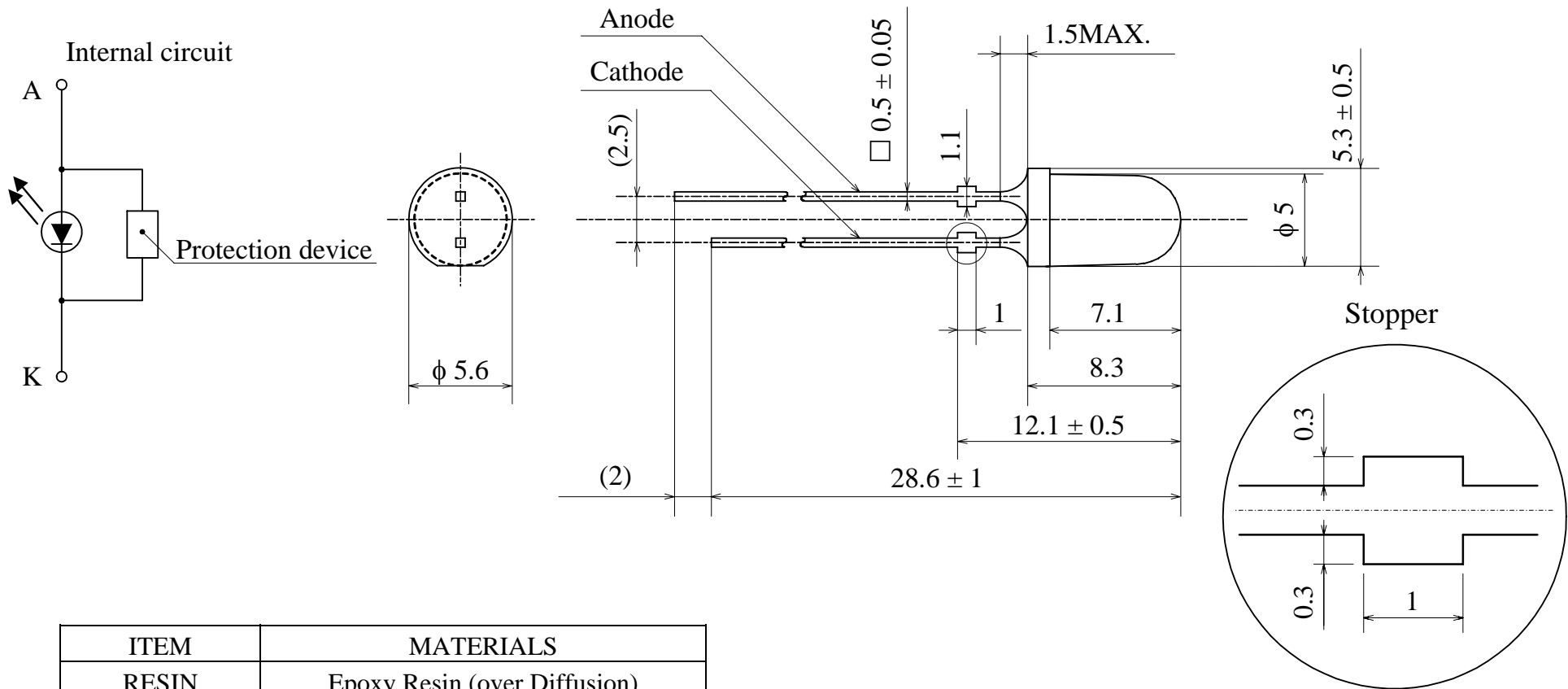

ITEM	MATERIALS
RESIN	Epoxy Resin (over Diffusion)
LEAD FRAME	Ag Plating Copper Alloy

- * Please note that the bare copper alloy showing at the cut end of the lead frame may be corroded under certain conditions. LEDs have some sharp edges and points, particularly lead frames. Please handle with care so as to avoid injuries.
- ** NSPU510CS has a protection device built in as a protection circuit against static electricity.

NICHIA CORPORATION	Model	NSPU510CS	Unit mm
	Title	OUTLINE DIMENSIONS	
	No.	070507764621	3/1 Scale
			Allow ± 0.2

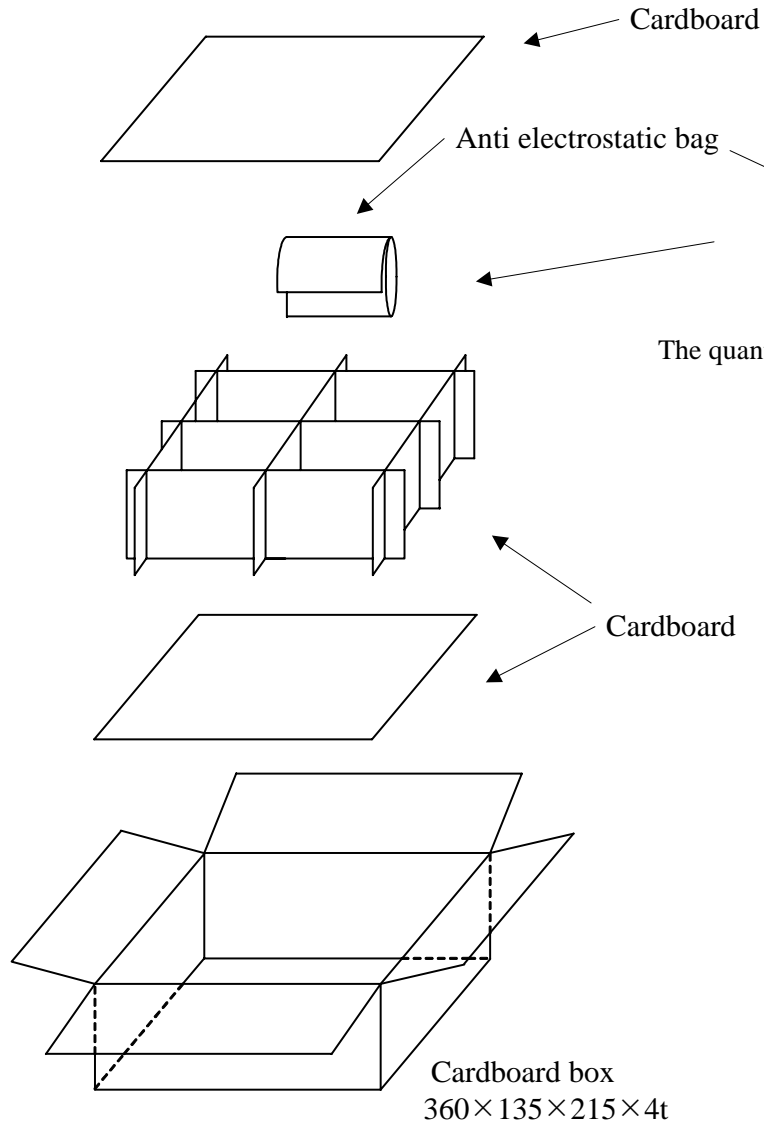

* One box contains 8 bags at maximum.

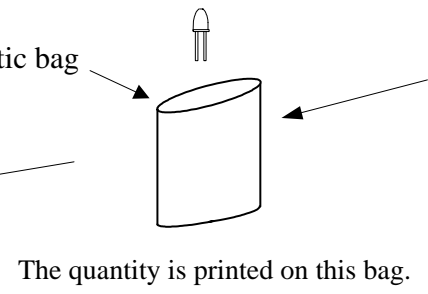

Print



NICHIA
UV LED
TYPE NSPUxxxxx
LOT xxxxxx-△■
QTY pcs
RoHS

NICHIA CORPORATION
491 OKA, KAMINAKA, ANAN, TOKUSHIMA, JAPAN

UV LED

LED放射
光学測定装置で
直接観察してはならない
クラス1M LED製品



LED RADIATION
DO NOT VIEW DIRECTLY WITH
OPTICAL INSTRUMENTS
CLASS 1M LED PRODUCT

**CAUTION TO
ELECTROSTATIC DAMAGE**
静電気に注意

Label



NICHIA

UV LED

TYPE NSPUxxxxx
LOT xxxxxx-△■
QTY PCS
RoHS

NICHIA CORPORATION
491 OKA, KAMINAKA, ANAN, TOKUSHIMA, JAPAN

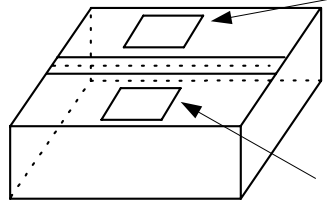

Caution Label

UV LED

LED放射
光学測定装置で
直接観察してはならない
クラス1M LED製品



LED RADIATION
DO NOT VIEW DIRECTLY WITH
OPTICAL INSTRUMENTS
CLASS 1M LED PRODUCT

* Put the label and caution label on the cardboard box.

NICHIA CORPORATION	Model	NSPUxxxxx
	Title	PACKING
	No.	070507764631

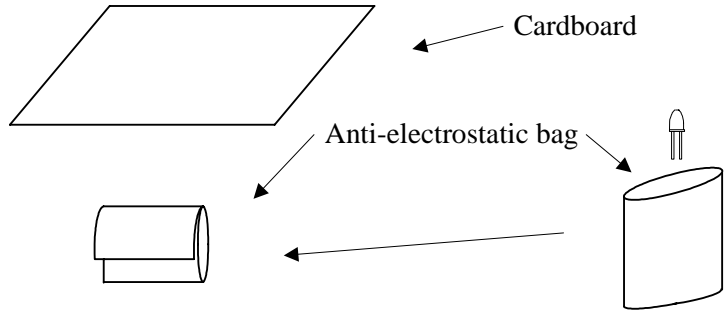

Print

NICHIA	
UV LED	
TYPE	NSPUxxxxx
LOT	xxxxxx-△■
QTY	pcs
NICHIA CORPORATION	
491 OKA, KAMINAKA, ANAN, TOKUSHIMA, JAPAN	

LED放射 光学測定装置で 直接観察してはならない クラス1M LED製品	UV LED 	LED RADIATION DO NOT VIEW DIRECTLY WITH OPTICAL INSTRUMENTS CLASS 1M LED PRODUCT
---	-------------------	--

CAUTION TO ELECTROSTATIC DAMAGE
静電気に注意

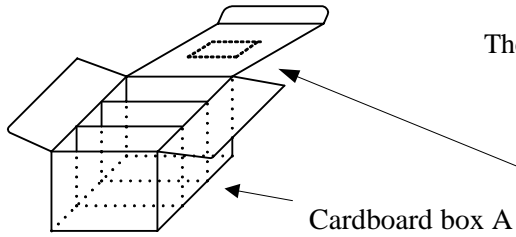

Caution Label

LED放射 光学測定装置で 直接観察してはならない クラス1M LED製品	UV LED 	LED RADIATION DO NOT VIEW DIRECTLY WITH OPTICAL INSTRUMENTS CLASS 1M LED PRODUCT
---	-------------------	--

* Put the caution label on the cardboard box A.

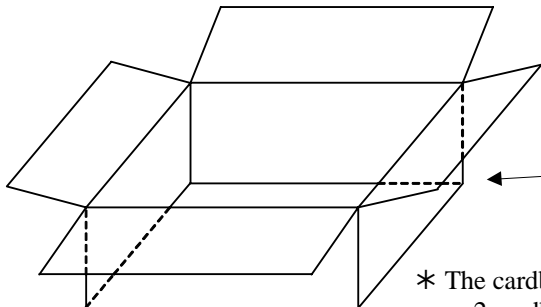
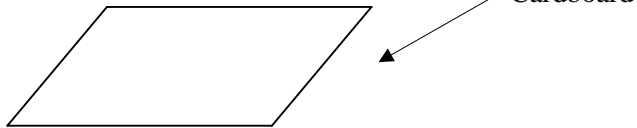
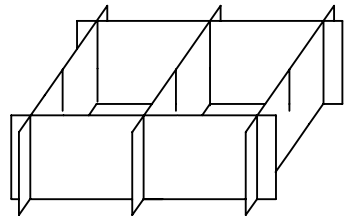

* The cardboard box B contains 2 cardboard box A at maximum.

Label

NICHIA	
UV LED	
TYPE	NSPUxxxxx
LOT	xxxxxx-△■
QTY	PCS
NICHIA CORPORATION	
491 OKA, KAMINAKA, ANAN, TOKUSHIMA, JAPAN	

* Put the label on the cardboard box B.

NICHIA CORPORATION	Model	NSPUxxxxx
	Title	PACKING
	No.	070507764641

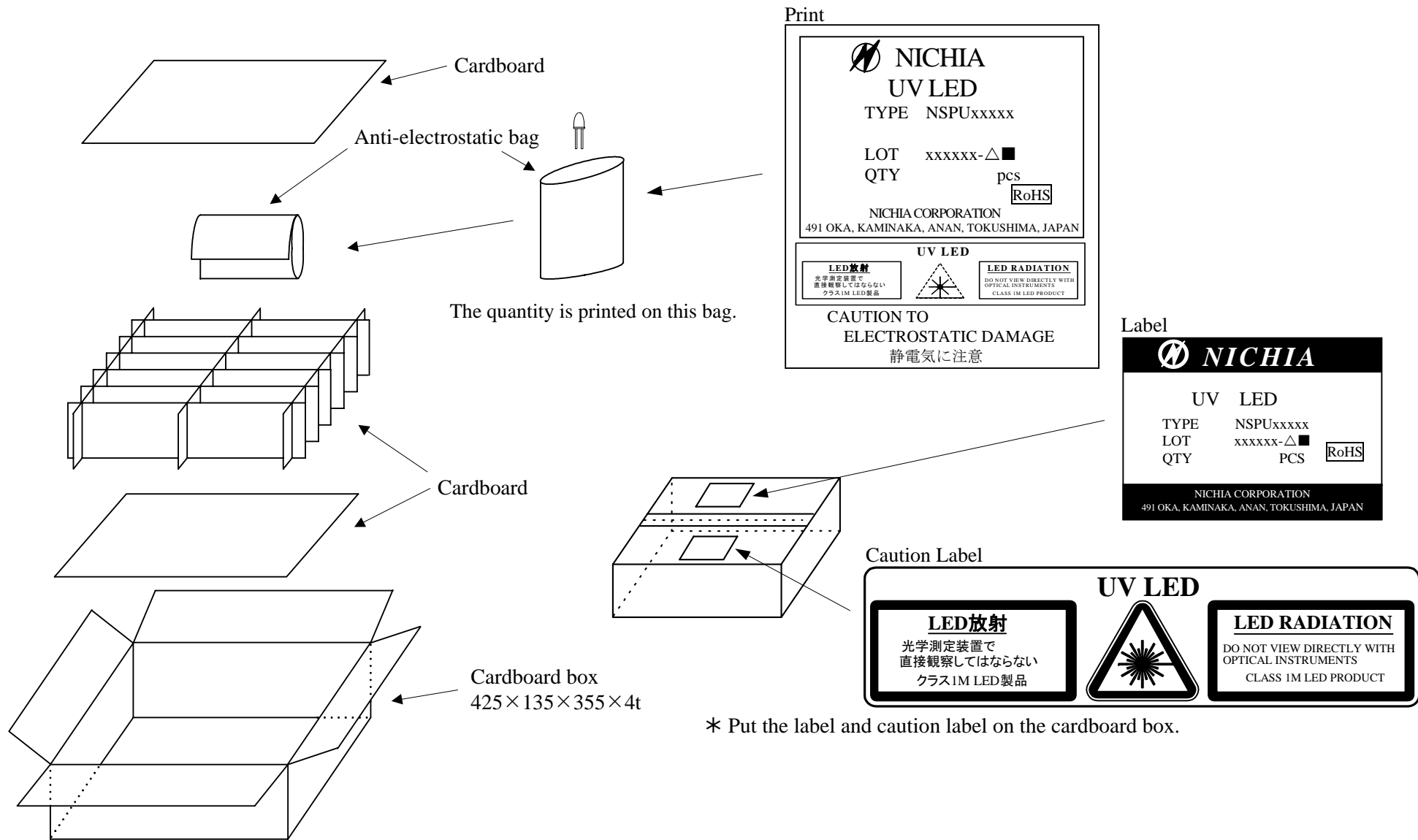

* One box contains 20 bags at maximum.

* Put the label and caution label on the cardboard box.

NICHIA CORPORATION	Model	NSPUxxxxx
	Title	PACKING
	No.	070507764651

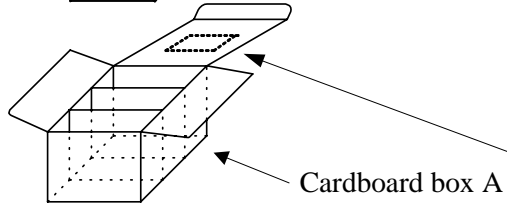
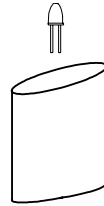
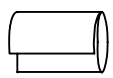
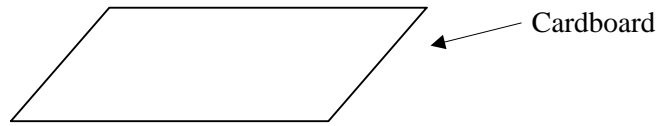

Print

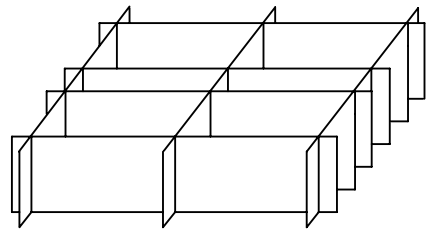

Caution Label



* Put the caution label on the cardboard box A.

Label

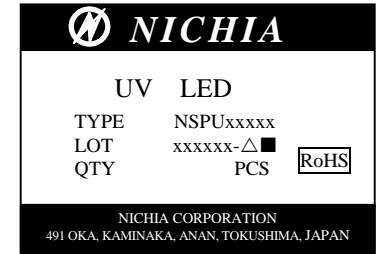

* Put the label on the cardboard box B.

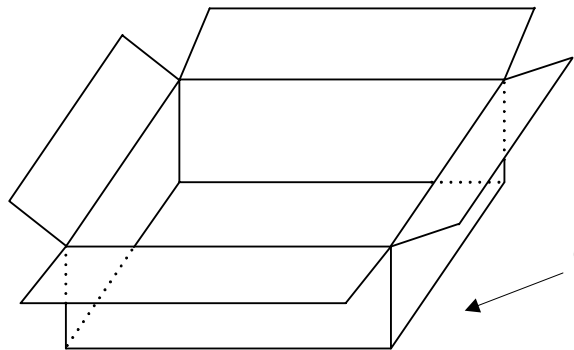
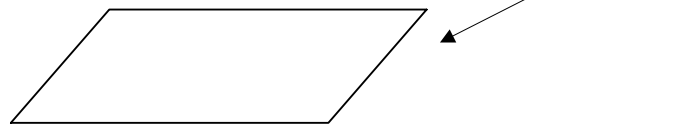

* The cardboard box B contains 4 cardboard box A at maximum.

NICHIA CORPORATION	Model	NSPUxxxxx	
	Title	PACKING	
	No.	070507764661	