

**NICHIA CORPORATION**

## **SPECIFICATIONS FOR UV LED**

### **NVCUQ048A**

- Built-in ESD Protection Device
- RoHS Compliant

## SPECIFICATIONS

### (1) Absolute Maximum Ratings

Item	Symbol	Absolute Maximum Rating	Unit
Forward Current	$I_F$	4.4	A
Allowable Reverse Current	$I_R$	85	mA
Power Dissipation	$P_D$	213	W
Operating Temperature	$T_{opr}$	0~85	°C
Storage Temperature	$T_{stg}$	-40~100	°C
Junction Temperature	$T_J$	130	°C

\* Absolute Maximum Ratings at  $T_{TH}=25^{\circ}\text{C}$ .

\* The operating Temperature range is the range of Thermistor temperatures ( $T_{TH}$ ).

\* Do not operate the LEDs in environments where temperature and humidity fluctuate greatly (i.e. causing condensation to form).

### (2) Initial Electrical/Optical Characteristics

Item		Symbol	Condition	Typ	Max	Unit
U365	Forward Voltage	$V_F$	$I_F=4\text{A}$	46.3	-	V
	Radiant Flux	$\Phi_e$	$I_F=4\text{A}$	68	-	W
	Peak Wavelength	$\lambda_p$	$I_F=4\text{A}$	365	-	nm
U385	Forward Voltage	$V_F$	$I_F=4\text{A}$	44.8	-	V
	Radiant Flux	$\Phi_e$	$I_F=4\text{A}$	81	-	W
	Peak Wavelength	$\lambda_p$	$I_F=4\text{A}$	385	-	nm
U395	Forward Voltage	$V_F$	$I_F=4\text{A}$	44.1	-	V
	Radiant Flux	$\Phi_e$	$I_F=4\text{A}$	78	-	W
	Peak Wavelength	$\lambda_p$	$I_F=4\text{A}$	395	-	nm
Spectrum Half Width		$\Delta \lambda$	$I_F=4\text{A}$	12	-	nm
Thermal Resistance		$R_{\theta JC}$	-	0.040	0.052	°C/W

\* Characteristics at  $T_{TH}=25^{\circ}\text{C}$ .

\* Radiant Flux value as per CIE 127:2007 standard.

\*  $R_{\theta JC}$  is the thermal resistance from the junction to the  $T_C$  measurement point. (Heat sink used: Copper,  $t=1.5\text{mm}$ , Thermal grease used:  $4.3\text{W}/\text{m}\cdot\text{K}$ ,  $t=0.1\text{mm}$ )

# RANKS

Item	Rank	Min	Max	Unit
Forward Voltage	B480	48.0	48.5	V
	B475	47.5	48.0	
	B470	47.0	47.5	
	B465	46.5	47.0	
	B460	46.0	46.5	
	B455	45.5	46.0	
	B450	45.0	45.5	
	B445	44.5	45.0	
	B440	44.0	44.5	
	B435	43.5	44.0	
	B430	43.0	43.5	
	B425	42.5	43.0	
Radiant Flux	Pw082	82.0	90.2	W
	Pw074f	74.5	82.0	
	Pw067h	67.7	74.5	
	Pw061g	61.6	67.7	
	Pw056	56.0	61.6	
Peak Wavelength	U395	390	400	nm
	U385	380	390	
	U365	360	370	

\* Ranking at T<sub>TH</sub>=25°C.

\* Forward Voltage Tolerance: ±0.35V

\* Radiant Flux Tolerance: ±6%

\* Peak Wavelength Tolerance: ±3nm

\* LEDs from the above ranks will be shipped. The rank combination ratio per shipment will be decided by Nichia.

## Forward Voltage Ranks by Peak Wavelength

Ranking by Forward Voltage \ Ranking by Peak Wavelength	B425	B430	B435	B440	B445	B450	B455	B460	B465	B470	B475	B480
U365												
U385												
U395												

## Radiant Flux Ranks by Peak Wavelength

Ranking by Radiant Flux \ Ranking by Peak Wavelength	Pw056	Pw061g	Pw067h	Pw074f	Pw082
U365					
U385,U395					

# OUTLINE DIMENSIONS

\* 本製品はRoHS指令に適合しております。  
This product complies with RoHS Directive.

NVCUQ048A  
管理番号 No. STS-DA7-15053

\* 括弧で囲まれた寸法は参考値です。  
The dimension(s) in parentheses are for reference purposes.

(単位 Unit: mm, 公差 Tolerance: ±0.2)

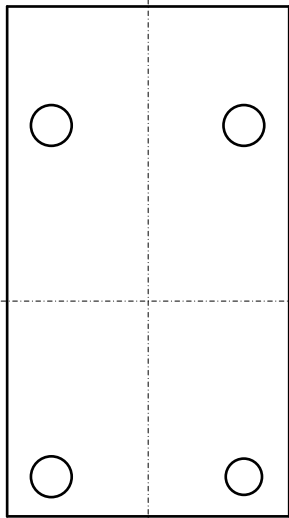
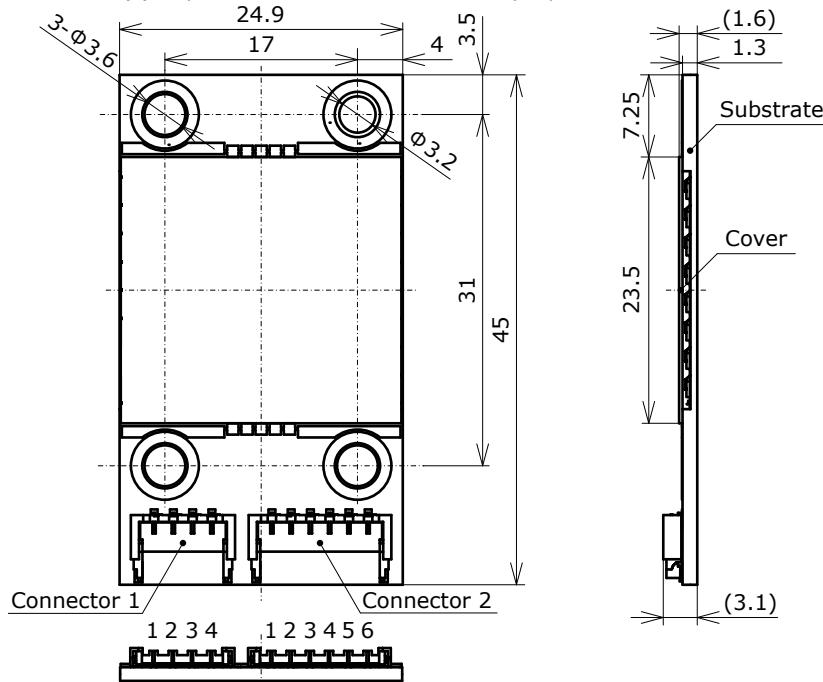

項目 Item	内容 Description
基板材質 Substrate Materials	窒化アルミニウム Aluminum Nitride
カバー材質 Cover Materials	硬質ガラス Hard Glass
コネクタ Connector	Hirose Electric DF65-4P-1.7V(21) DF65-6P-1.7V(21)
質量 Weight	4.4g(TYP)

\* 本製品ははんだ付けに非対応です。はんだ付けでの使用をしないで下さい。  
This product is non-soldering-compliant.  
Do not solder this product.

\* 製品と筐体間の接続には放熱グリスなど低熱抵抗の放熱材料を用いることを推奨します。  
When attaching the LEDs to the heat sink, etc., Nichia recommends using a thermal interface material that has a low thermal resistance (i.e. thermal grease).

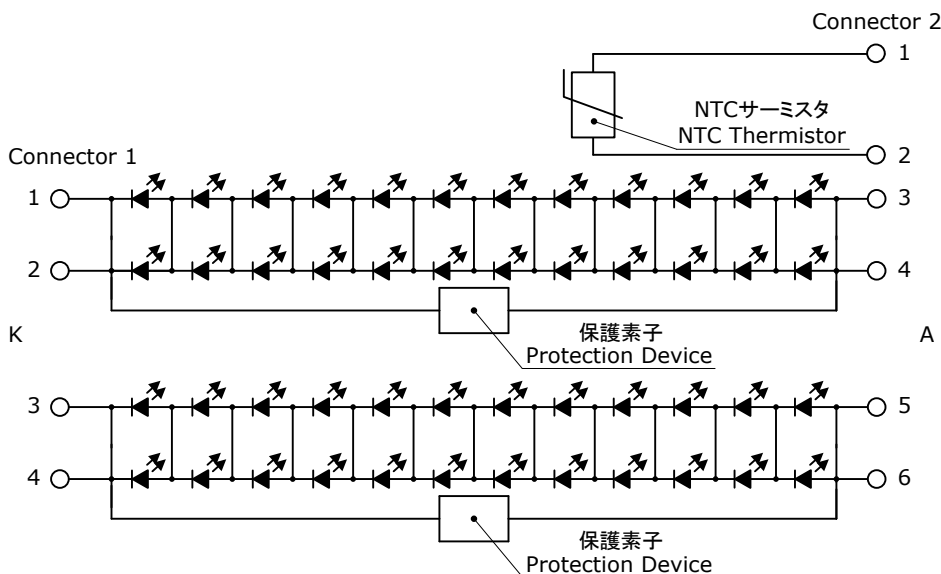

# TRAY DIMENSIONS

- \* 数量は1トレイにつき 6個入りです。  
Tray Size: 6pcs
- \* 寸法は参考です。  
All dimensions shown are for reference only and are not guaranteed.

Nxxxx048x  
管理番号 No. STS-DA7-15054

(単位 Unit: mm)

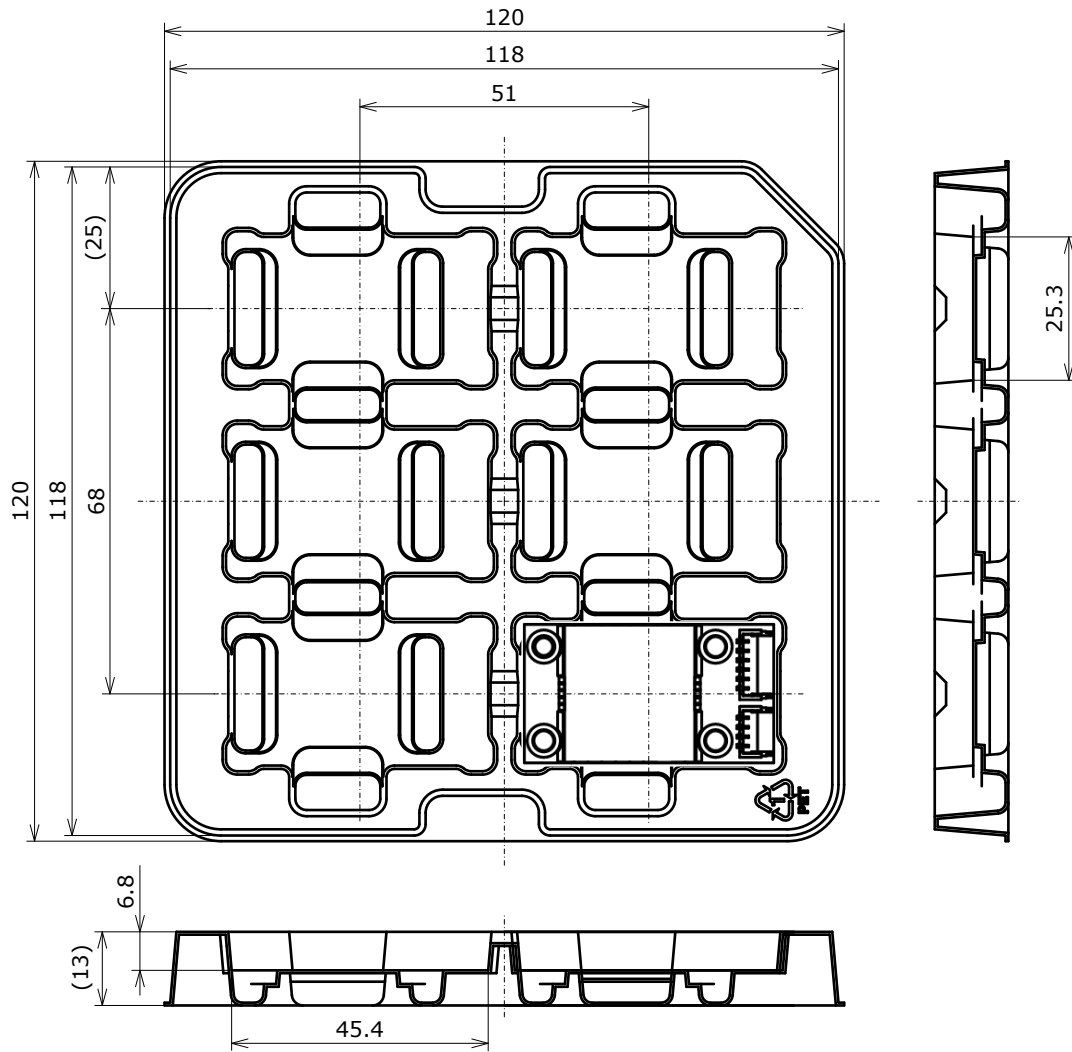

PACKAGING - TRAY PACK

シリカゲルとともにトレイをアルミ防湿袋に入れ、熱シールにより封をします。  
Trays are shipped with desiccants in heat-sealed moisture-proof bags.

Nxxxxxxx  
管理番号 No. STS-DA7-12138A

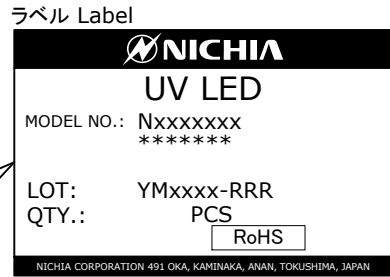
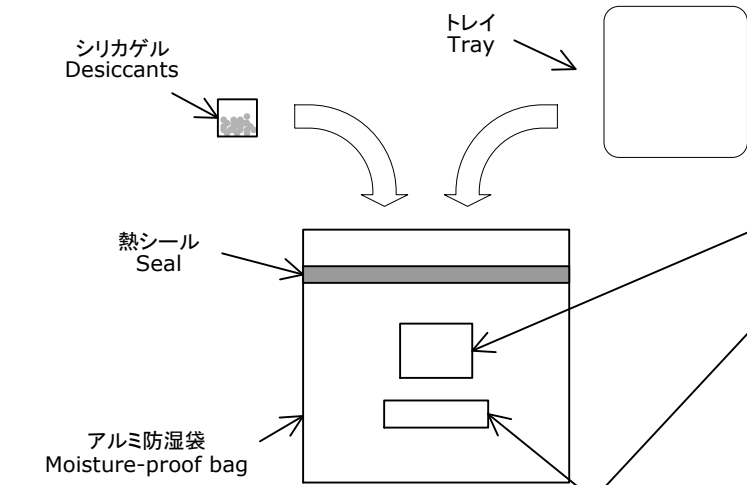

アルミ防湿袋を入れます。  
Moisture-proof bags are packed in cardboard boxes.

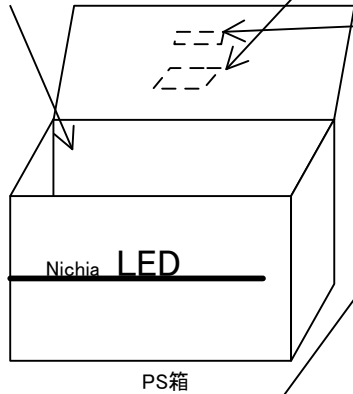

警告ラベル Warning and Explanatory Labels

**UV LED**

- ・「UV LEDは紫外領域の光(UV光)を発生します。」
- ・「UV光は人間の目には見えませんが、光が見えていなくてもUV光により目を傷める可能性があります。」
- ・「UV光を直接目にあてないでください。必ず適切な防具を着用してください。」
- ・「UV LEDを組み込んだ製品には、適切な警告表示をしてください。」

- ・ UV LEDs emit light in the ultraviolet region (UV light).
- ・ UV light is invisible and may be harmful to the human eye.
- ・ Do not expose the eyes directly to the UV light. Wear appropriate protective gear when handling.
- ・ Use appropriate warning signs/labels on devices using the UV LEDs.

PS箱を並べて入れ、ダンボールで仕切ります。  
PS boxes are packed in cardboard boxes with corrugated partitions.

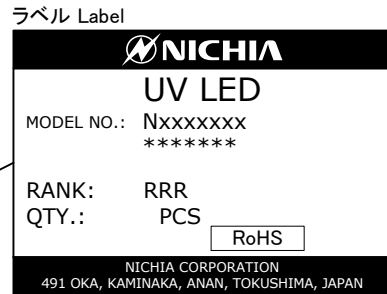
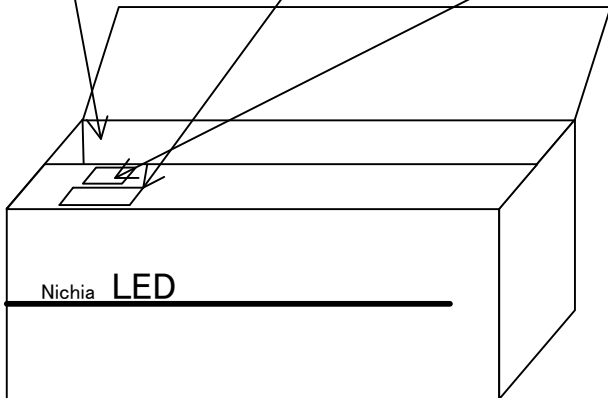

- \* 客先型名を\*\*\*\*\*で示します。客先型名が設定されていない場合は空白です。  
\*\*\*\*\* is the customer part number. If not provided, it will not be indicated on the label.
- \* ロット表記方法についてはロット番号の項を参照して下さい。  
For details, see "LOT NUMBERING CODE" in this document.

- \* 本製品はトレイに入れたのち、輸送の衝撃から保護するためダンボールで梱包します。  
Products shipped on trays are packed in a moisture-proof bag. They are shipped in cardboard boxes to protect them from external forces during transportation.
- \* 取り扱いに際して、落下させたり、強い衝撃を与えたりしますと、製品を損傷させる原因になりますので注意して下さい。  
Do not drop or expose the box to external forces as it may damage the products.
- \* ダンボールには防水加工がされておらず、梱包箱が水に濡れないよう注意して下さい。  
Do not expose to water. The box is not water-resistant.
- \* 輸送、運搬に際して弊社よりの梱包状態あるいは同等の梱包を行って下さい。  
Using the original package material or equivalent in transit is recommended.

## LOT NUMBERING CODE

Lot Number is presented by using the following alphanumeric code.

YMxxxx - RRR

Y - Year

Year	Y
2018	I
2019	J
2020	K
2021	L
2022	M
2023	N

M - Month

Month	M	Month	M
1	1	7	7
2	2	8	8
3	3	9	9
4	4	10	A
5	5	11	B
6	6	12	C

xxxx-Nichia's Product Number

RRR-Ranking by Wavelength, Ranking by Radiant Flux, Ranking by Forward Voltage

# DERATING CHARACTERISTICS

\*  $R_{\theta JTH}$ の算出は注意事項熱の発生を参照して下さい。  
 For calculation of  $R_{\theta JTH}$ , see the "Thermal Management" of this specification.

NVCUQ048A  
 管理番号 No. STS-DA7-15055

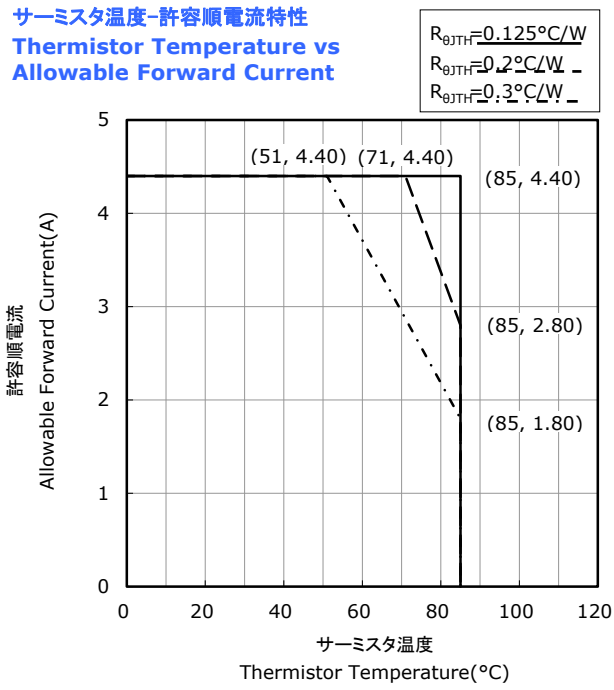



# OPTICAL CHARACTERISTICS

\* 本特性は参考です。  
All characteristics shown are for reference only and are not guaranteed.

NVCUQ048A  
管理番号 No. STS-DA7-15056

## 発光スペクトル Spectrum

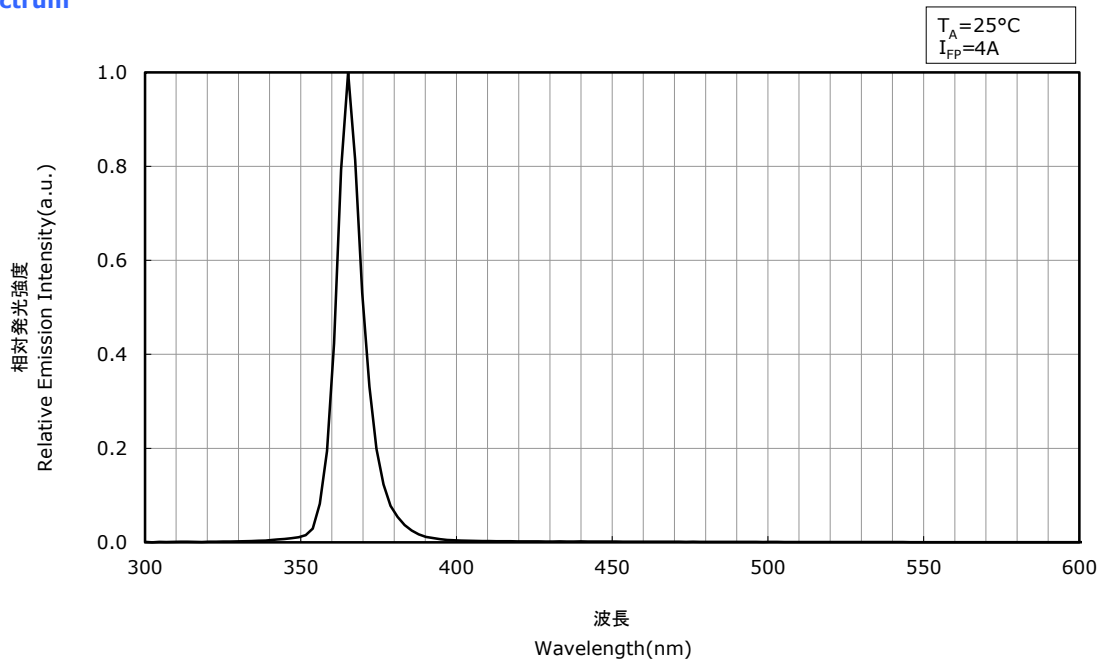

## 指向特性 Directivity

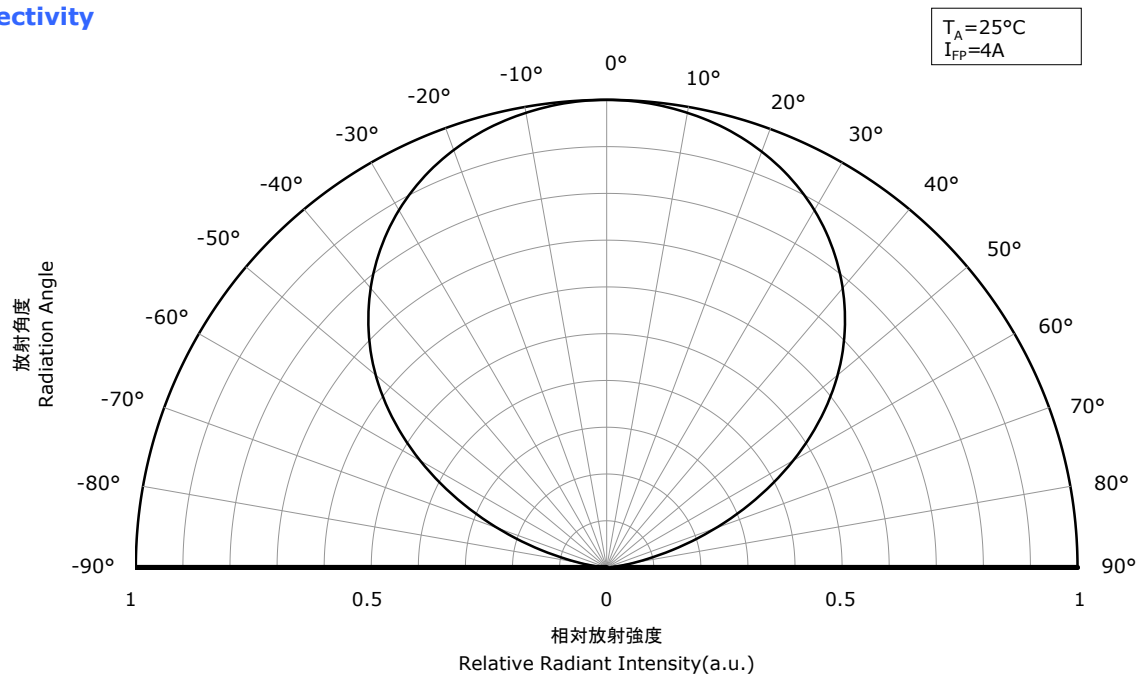

\* 本特性はピーク波長ランクU365xに対応しています。  
The graphs above show the characteristics for U365x LEDs of this product.

# OPTICAL CHARACTERISTICS

\* 本特性は参考です。  
All characteristics shown are for reference only and are not guaranteed.

NVCUQ048A  
管理番号 No. STS-DA7-15057

## 発光スペクトル Spectrum

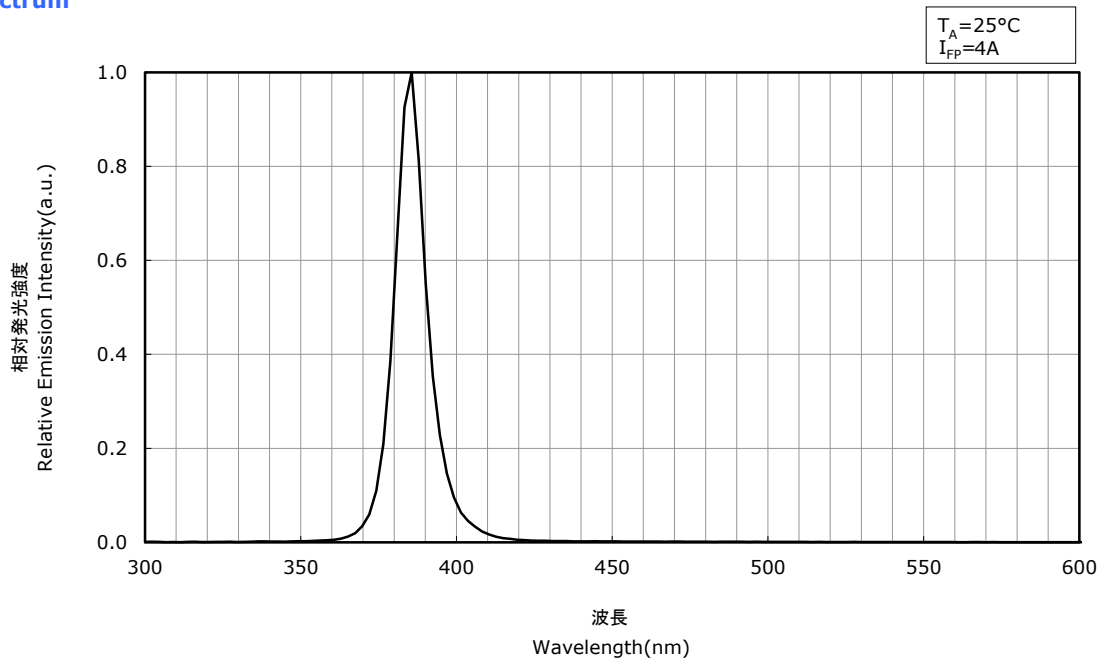

## 指向特性 Directivity

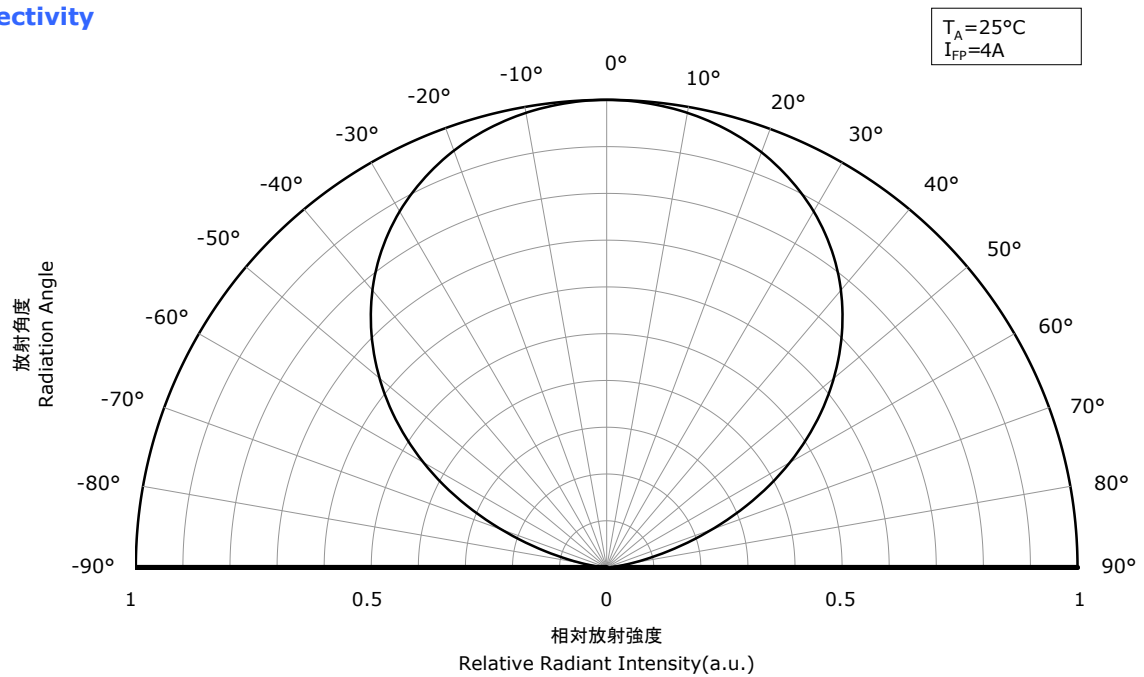

\* 本特性はピーク波長ランクU385xに対応しています。  
The graphs above show the characteristics for U385x LEDs of this product.

# OPTICAL CHARACTERISTICS

\* 本特性は参考です。  
All characteristics shown are for reference only and are not guaranteed.

NVCUQ048A  
管理番号 No. STS-DA7-15058

## 発光スペクトル Spectrum

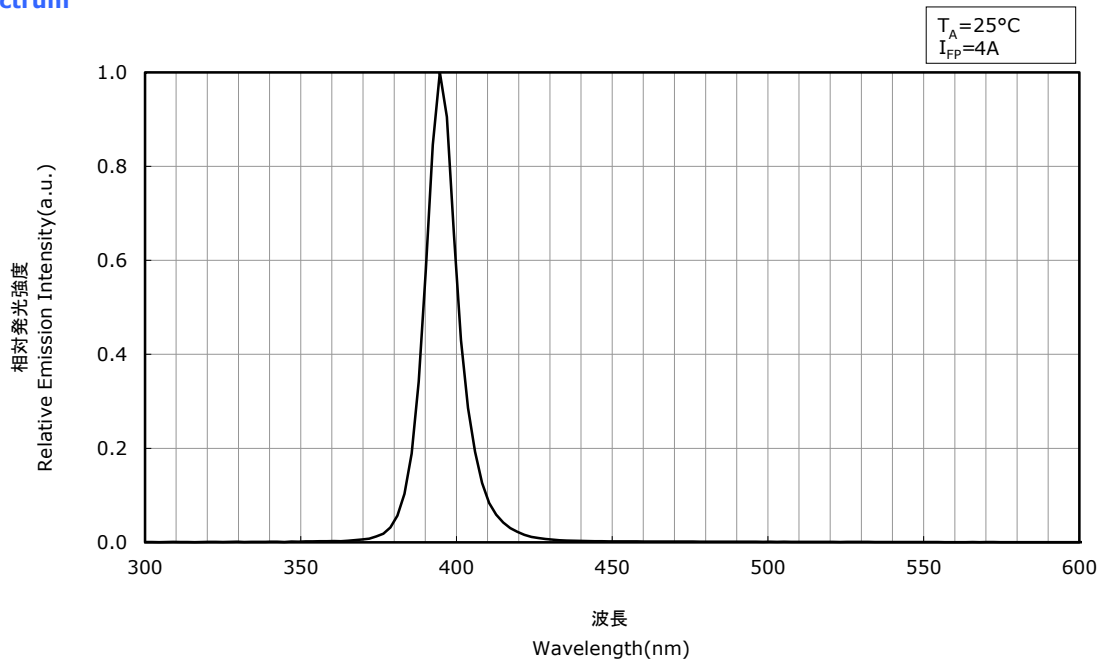

## 指向特性 Directivity

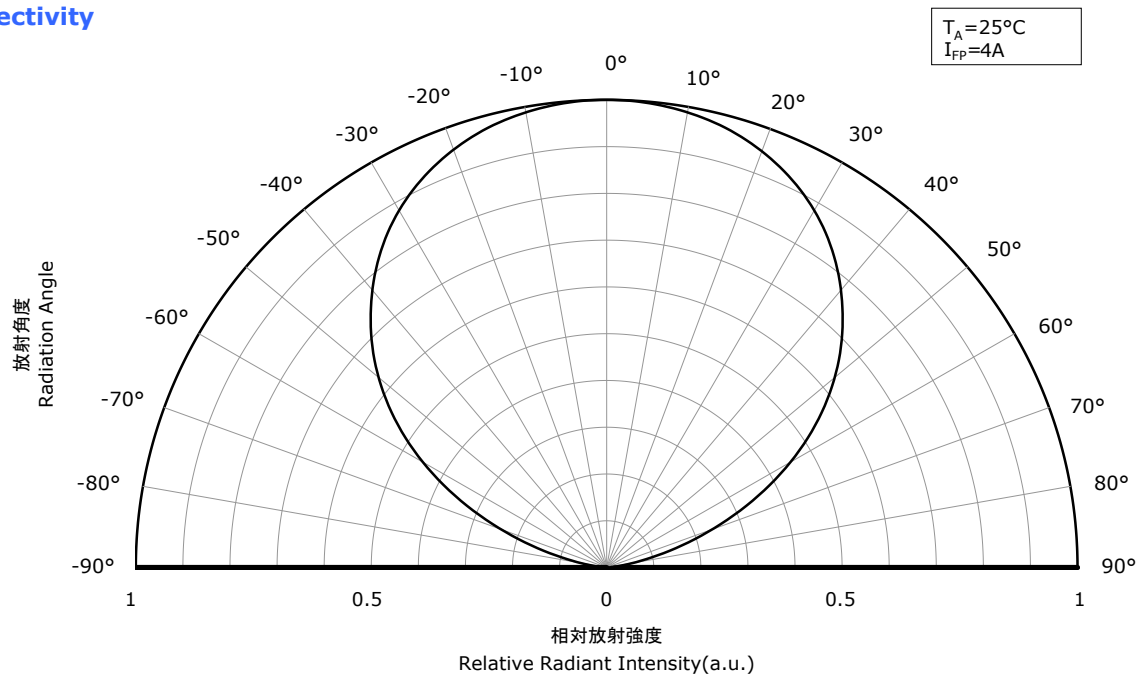

\* 本特性はピーク波長ランクU395xに対応しています。  
The graphs above show the characteristics for U395x LEDs of this product.

# FORWARD CURRENT CHARACTERISTICS / TEMPERATURE CHARACTERISTICS

\* 本特性は参考です。  
All characteristics shown are for reference only and are not guaranteed.

NVCUQ048A  
管理番号 No. STS-DA7-15059

順電圧-順電流特性  
Forward Voltage vs  
Forward Current

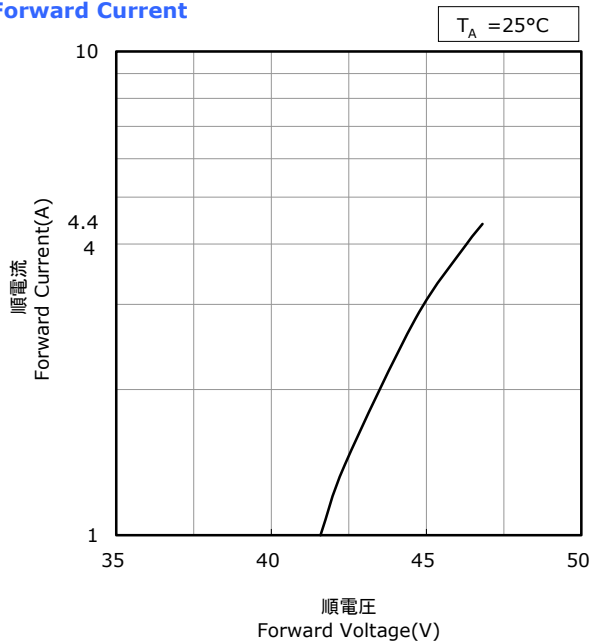

周囲温度-順電圧特性  
Ambient Temperature vs  
Forward Voltage

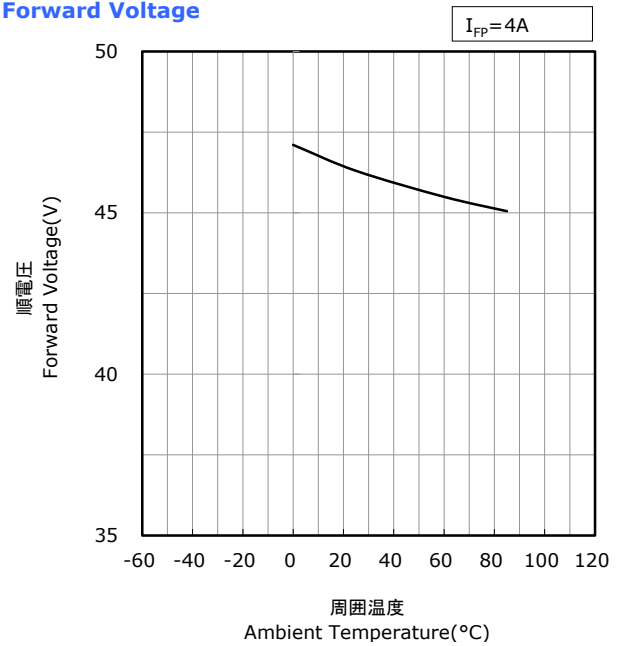

順電流-相対放射束特性  
Forward Current vs  
Relative Radiant Flux

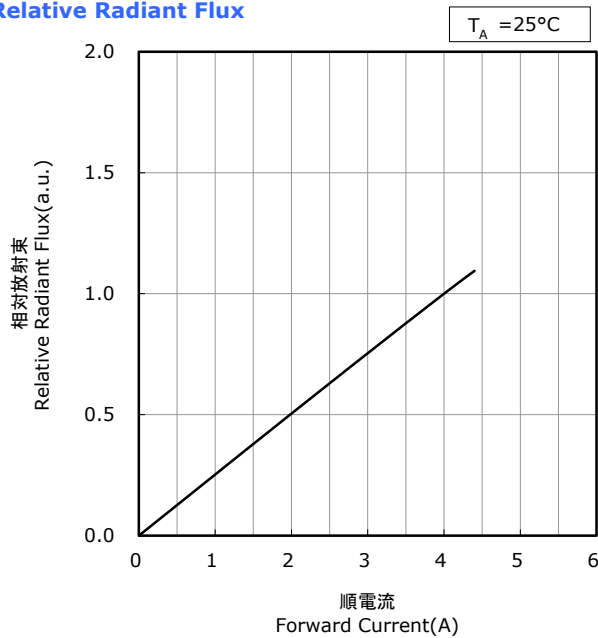

周囲温度-相対放射束特性  
Ambient Temperature vs  
Relative Radiant Flux

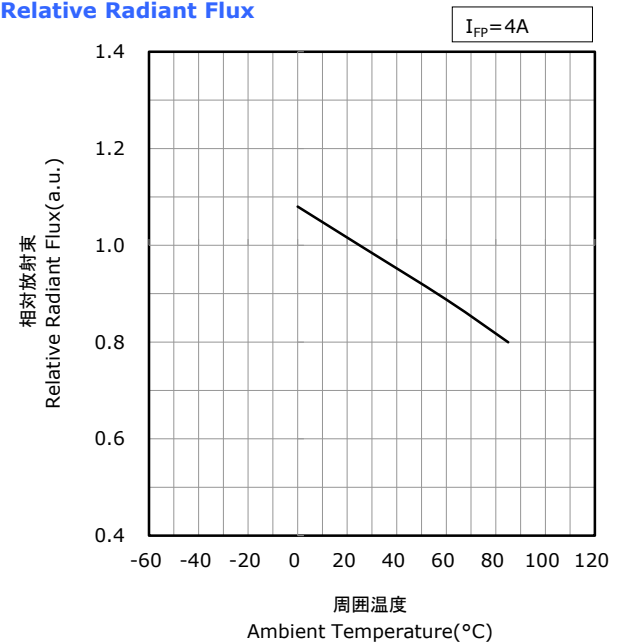

\* 本特性はピーク波長ランクU365xに対応しています。  
The graphs above show the characteristics for U365x LEDs of this product.

# FORWARD CURRENT CHARACTERISTICS / TEMPERATURE CHARACTERISTICS

\* 本特性は参考です。  
All characteristics shown are for reference only and are not guaranteed.

NVCUQ048A  
管理番号 No. STS-DA7-15060

順電圧-順電流特性  
Forward Voltage vs  
Forward Current

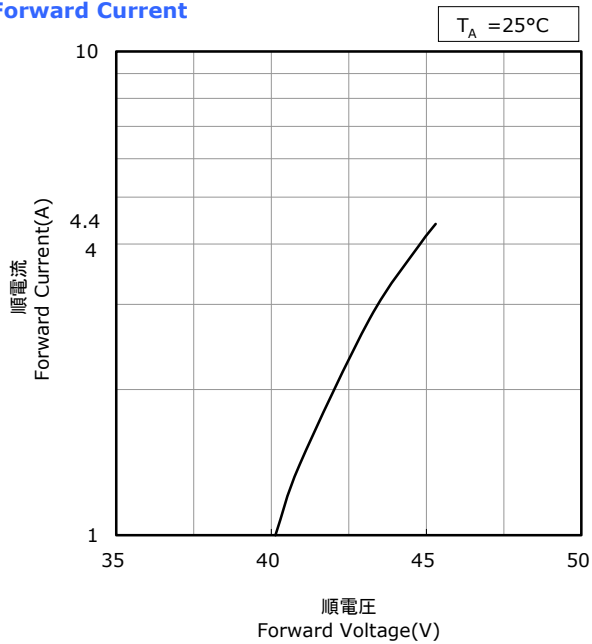

周囲温度-順電圧特性  
Ambient Temperature vs  
Forward Voltage

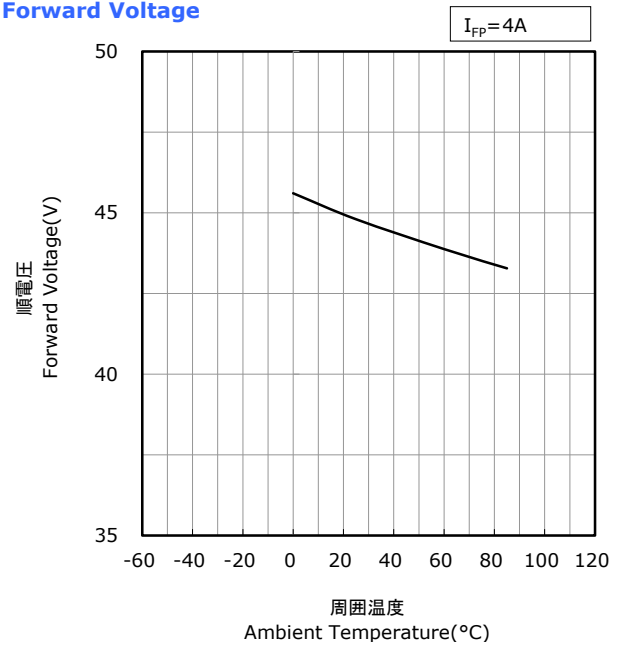

順電流-相対放射束特性  
Forward Current vs  
Relative Radiant Flux

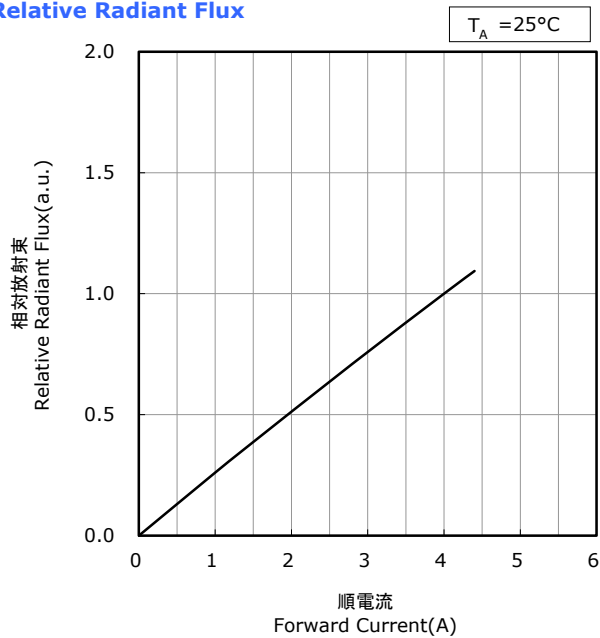

周囲温度-相対放射束特性  
Ambient Temperature vs  
Relative Radiant Flux

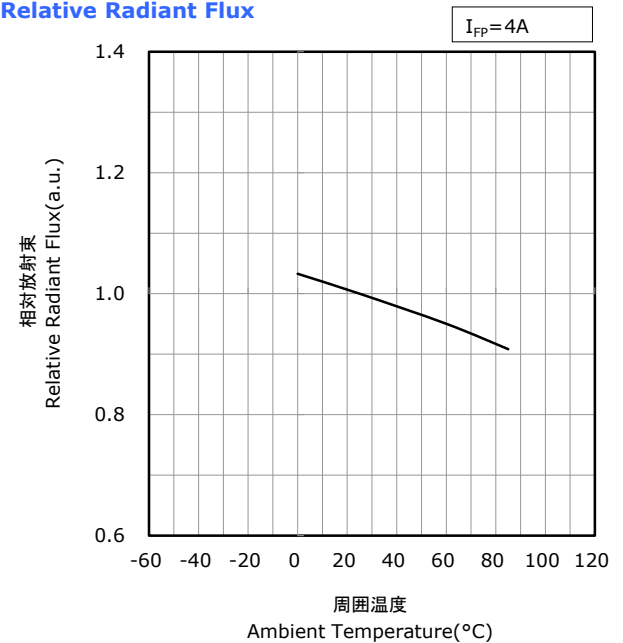

\* 本特性はピーク波長ランクU385xに対応しています。  
The graphs above show the characteristics for U385x LEDs of this product.

# FORWARD CURRENT CHARACTERISTICS / TEMPERATURE CHARACTERISTICS

\* 本特性は参考です。  
All characteristics shown are for reference only and are not guaranteed.

NVCUQ048A  
管理番号 No. STS-DA7-15061

順電圧-順電流特性  
Forward Voltage vs  
Forward Current

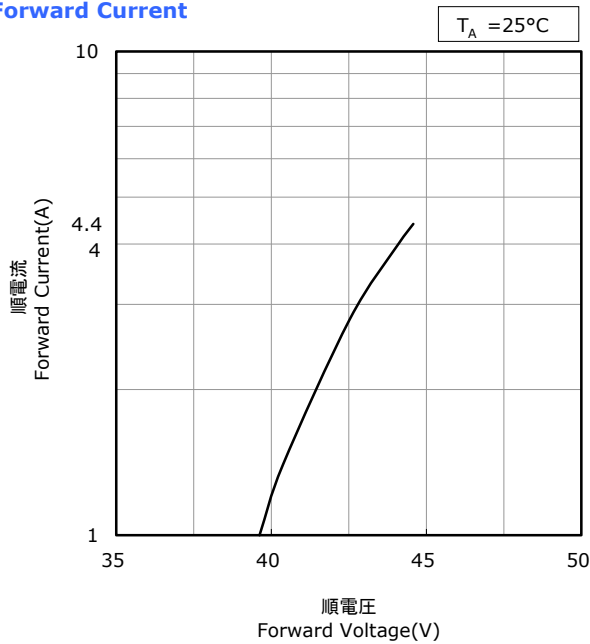

周囲温度-順電圧特性  
Ambient Temperature vs  
Forward Voltage

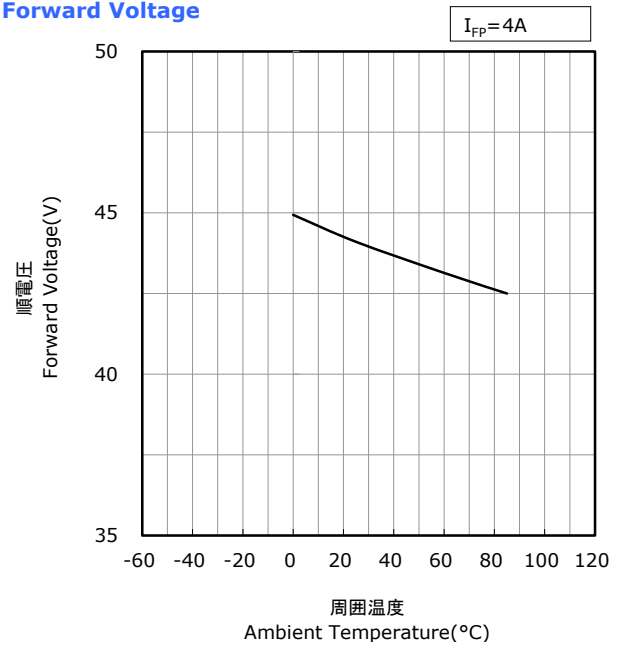

順電流-相対放射束特性  
Forward Current vs  
Relative Radiant Flux

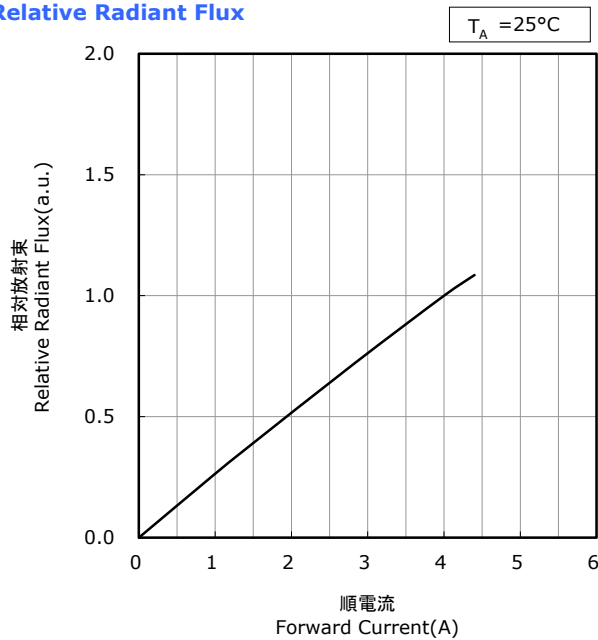

周囲温度-相対放射束特性  
Ambient Temperature vs  
Relative Radiant Flux

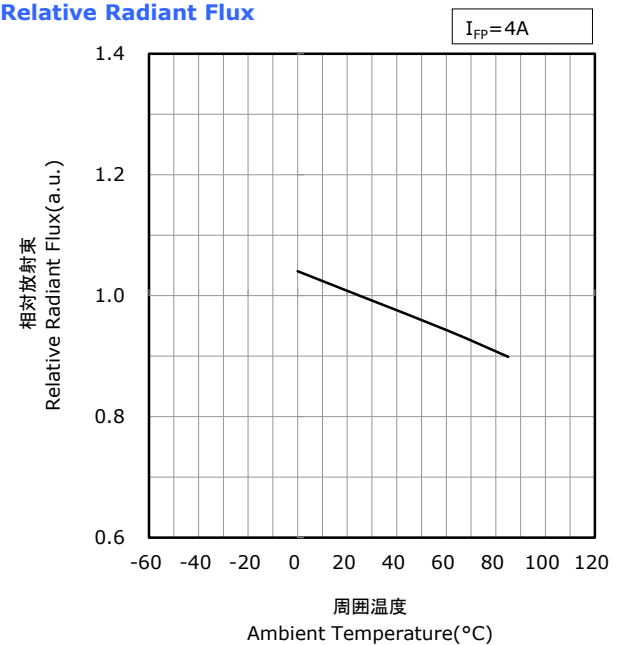

\* 本特性はピーク波長ランクU395xに対応しています。  
The graphs above show the characteristics for U395x LEDs of this product.

FORWARD CURRENT CHARACTERISTICS / TEMPERATURE CHARACTERISTICS

\* 本特性は参考です。  
All characteristics shown are for reference only and are not guaranteed.

NVCUQ048A  
管理番号 No. STS-DA7-15062

順電流-ピーク波長特性  
Forward Current vs  
Peak Wavelength

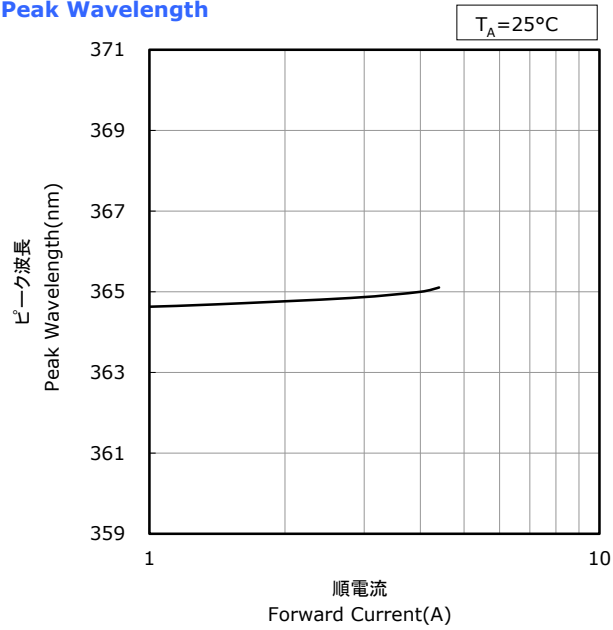

周囲温度-ピーク波長特性  
Ambient Temperature vs  
Peak Wavelength

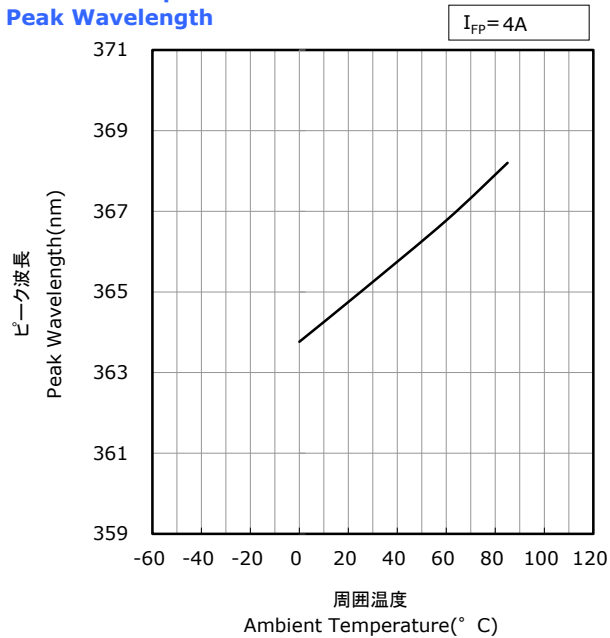

\* 本特性はピーク波長ランクU365xに対応しています。  
The graphs above show the characteristics for U365x LEDs of this product.

FORWARD CURRENT CHARACTERISTICS / TEMPERATURE CHARACTERISTICS

\* 本特性は参考です。  
All characteristics shown are for reference only and are not guaranteed.

NVCUQ048A  
管理番号 No. STS-DA7-15063

順電流-ピーク波長特性  
Forward Current vs Peak Wavelength

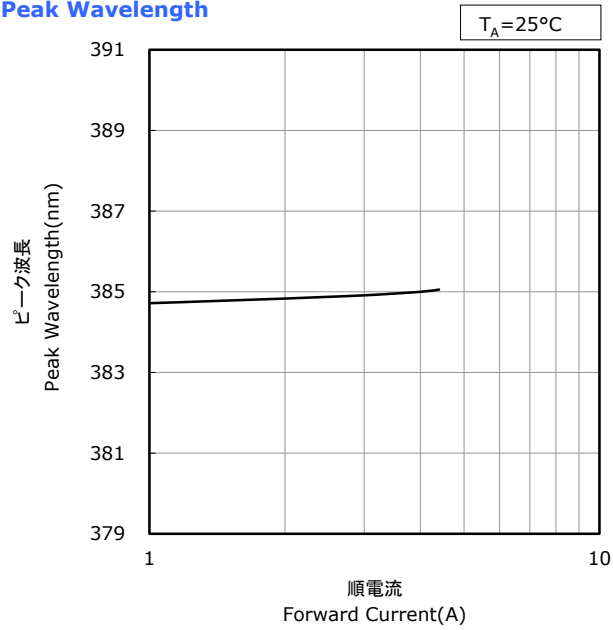

周囲温度-ピーク波長特性  
Ambient Temperature vs Peak Wavelength

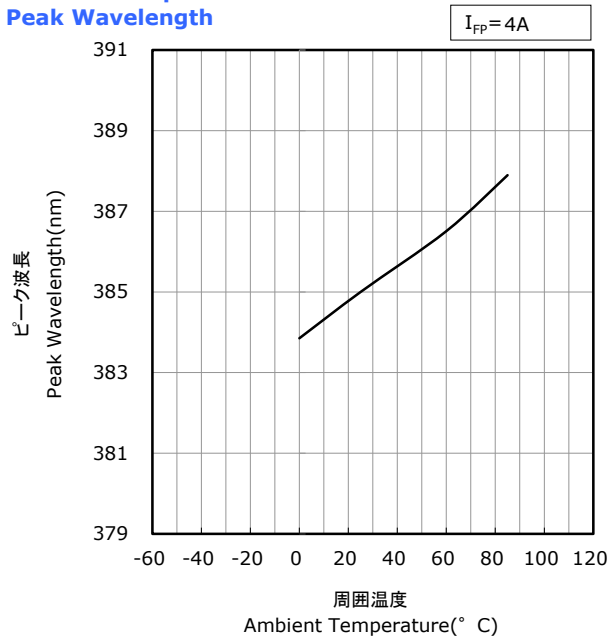

\* 本特性はピーク波長ランクU385xに対応しています。  
The graphs above show the characteristics for U385x LEDs of this product.



FORWARD CURRENT CHARACTERISTICS / TEMPERATURE CHARACTERISTICS

\* 本特性は参考です。  
All characteristics shown are for reference only and are not guaranteed.

NVCUQ048A  
管理番号 No. STS-DA7-15064

順電流-ピーク波長特性  
Forward Current vs Peak Wavelength

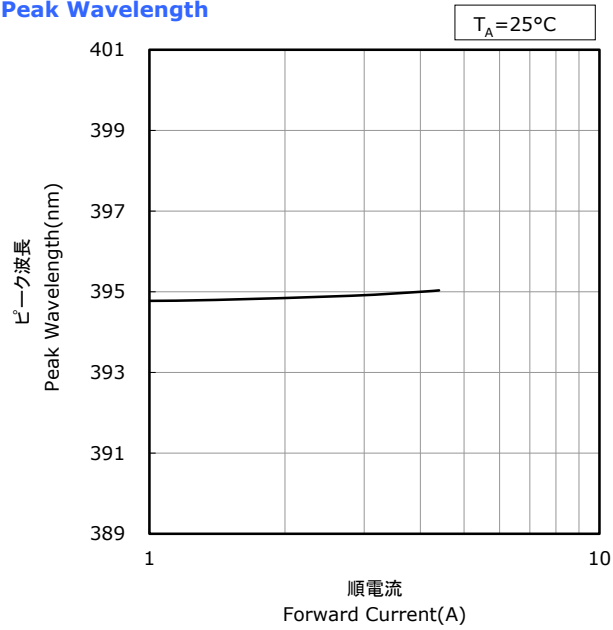

周囲温度-ピーク波長特性  
Ambient Temperature vs Peak Wavelength

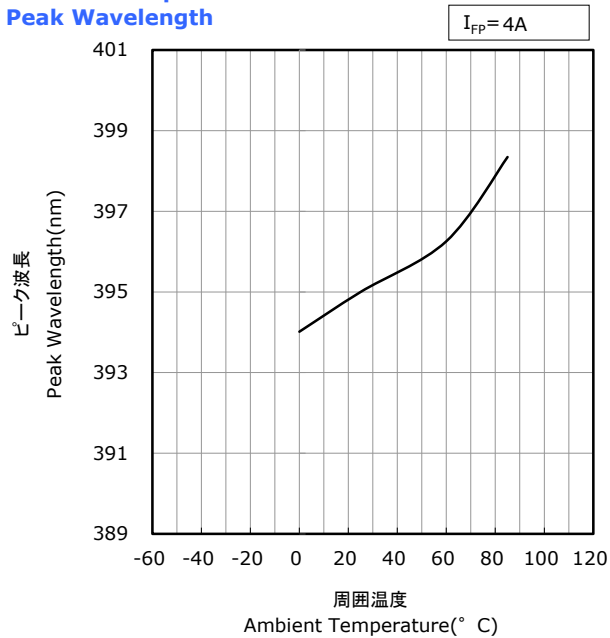

\* 本特性はピーク波長ランクU395xに対応しています。  
The graphs above show the characteristics for U395x LEDs of this product.

## RELIABILITY

### (1) Tests and Results

Test	Reference Standard	Test Conditions	Test Duration	Failure Criteria #	Units Failed/Tested
Thermal Shock(Air to Air)		-40°C to 100°C, 15min dwell	1000cycles	#1	0/2
High Temperature Storage	JEITA ED-4701 200 201	T <sub>A</sub> =100°C	1000hours	#1	0/2
Low Temperature Storage	JEITA ED-4701 200 202	T <sub>A</sub> =-40°C	1000hours	#1	0/2
Room Temperature Operating Life		T <sub>A</sub> =25°C, T <sub>W</sub> =30°C, I <sub>F</sub> =4.4A	1000hours	#1	0/2
Vibration	JEITA ED-4701 400 403	200m/s <sup>2</sup> , 100~2000~100Hz, 4cycles, 4min, each X, Y, Z	48minutes	#1	0/2
Electrostatic Discharges	JEITA ED-4701 300 304	HBM, 2kV, 1.5kΩ, 100pF, 3pulses, alternately positive or negative		#1	0/2

NOTES:

- 1) R<sub>θJT</sub>≈0.123°C/W
- 2) T<sub>W</sub>= Cooling Water Temperature: °C
- 3) Measurements are performed after allowing the LEDs to return to room temperature.

### (2) Failure Criteria

Criteria #	Items	Conditions	Failure Criteria
#1	Forward Voltage(V <sub>F</sub> )	I <sub>F</sub> =4A	>Initial value×1.1
	Radiant Flux(Φ <sub>E</sub> )	I <sub>F</sub> =4A	<Initial value×0.7

## CAUTIONS

### (1) Storage

Conditions		Temperature	Humidity	Time
Storage	Before Opening Aluminum Bag	$\leq 30^{\circ}\text{C}$	$\leq 90\% \text{RH}$	Within 1 Year from Delivery Date
	After Opening Aluminum Bag	$\leq 30^{\circ}\text{C}$	$\leq 70\% \text{RH}$	$\leq 168 \text{hours}$

- After opening the moisture-proof aluminum bag, the LEDs should be installed into an end product immediately. If a PCB is used to mount the LEDs before installing into an end product, these processes must be completed within the range of the conditions stated above. Unused remaining LEDs should be stored with silica gel desiccants in a hermetically sealed container, preferably the original moisture-proof bags for storage and resealing this bag.
- This LED has gold-plated parts; if the LEDs are exposed to a corrosive environment, it may cause the plated surface to tarnish causing issues. Ensure that when storing LEDs, a hermetically sealed container is used. Nichia recommends placing them back to the original moisture-proof bag and reseal it.
- To prevent substances/gases from affecting the plated surface, ensure that the parts/materials used with the LEDs in the same assembly/system do not contain sulfur (e.g. gasket/seal, adhesive, etc.). If the plating is contaminated, it may cause issues (e.g. electric connection failures). If a gasket/seal is used, silicone rubber gaskets/seals are recommended; ensure that this use of silicone does not result in issues (e.g. electrical connection failures) caused by low molecular weight volatile siloxane.
- To avoid condensation, the LEDs must not be stored in areas where temperature and humidity fluctuate greatly.
- Do not store the LEDs in a dusty environment.
- Do not expose the LEDs to direct sunlight and/or an environment over a long period of time where the temperature is higher than normal room temperature.

### (2) Directions for Use

- Nichia recommends designing the circuit to ensure that each LED is driven by a separate power supply.
- If two or more LEDs are connected in parallel, the current will be split between them (i.e. current division); this may cause the currents flowing through the LEDs to vary due to the variation in the forward voltage characteristics of the LEDs on the circuit, and in some cases, excessive current (i.e. exceeding the Absolute Maximum Rating). The circuit must be designed to ensure that the Absolute Maximum Ratings are not exceeded for each LED. The LEDs should be operated at a constant current per LED. In the case of operating at a constant voltage, Circuit B is recommended. If Circuit A is used, it may cause issues (i.e. a variation in the current flowing through the LEDs).

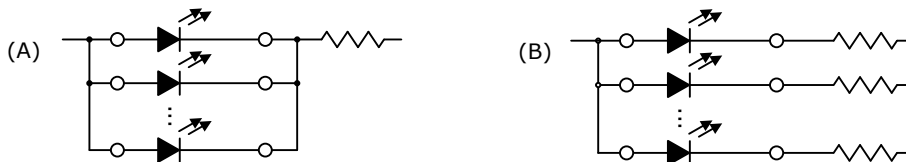

- This LED is designed to be operated at a forward current. Ensure that no voltage is applied to the LED in the forward/reverse direction while the LED is off. If the LEDs are used in an environment where reverse voltages are applied to the LED continuously, it may cause electrochemical migration to occur causing the LED to be damaged. When not in use for a long period of time, the system's power should be turned off to ensure that there are no issues/damage.
- To stabilize the LED characteristics while in use, Nichia recommends that the LEDs are operated at currents  $\geq 10\%$  of the sorting current.
- Ensure that transient excessive voltages (e.g. lighting surge) are not applied to the LEDs.
- If the LEDs are used for outdoor applications, ensure that necessary measures are taken (e.g. protecting the LEDs from water/salt damage and high humidity).
- Although this LED is specifically designed to emit invisible light, a small amount of light in the visible region exists in the emission spectrum. Ensure that when using the LEDs for sensors, verification is performed to ensure that the emission spectrum is fit for the intended use.
- If this product is stored and/or used constantly under high humidity conditions, it may accelerate the deterioration of the die; this may cause the radiant flux to decrease. If the LEDs are stored and/or used under these conditions, sufficient verification must be done prior to use to ensure there are no issues for the chosen application.
- Do not design this LED into applications where condensation may occur. If the LEDs are stored/operated in these environments, it may cause issues (e.g. current leaks that cause the radiant flux to decrease).

### (3) Handling Precautions

- Do not handle the LEDs with bare hands as it will contaminate the LED surface and may affect the optical characteristics: it might cause the LED to be deformed and/or the wire to break, which will cause the LED not to illuminate. The lead could also cause an injury.
- Ensure that when handling the LEDs with tweezers, excessive force is not applied to the LED. Otherwise, it may cause damage to the lens and/or the substrate (e.g. cut, scratch, chip, crack, delamination, and deformation) and the wire to break causing a catastrophic failure (i.e. the LED not to illuminate).
- Dropping may cause damage to the LED (e.g. deformation).
- Do not stack the LEDs on top of one another, regardless of whether the LEDs are attached to heat sinks or not. Otherwise, it may cause damage to the lens and the substrate (e.g. cut, scratch, chip, crack, delamination, and deformation) and the wire to break causing a catastrophic failure (i.e. the LED not to illuminate).

### (4) Design Consideration

- Volatile organic compounds that have been released from materials present around the LEDs (e.g. housing, gasket/seal, adhesive, secondary lens, lens cover, thermal grease, etc.) may adhere to the LED glass cover and other areas (e.g. package). If the LEDs are being used in a hermetically sealed environment, these volatile compounds can discolor after being exposed to heat and/or photon energy and it may greatly reduce the LED light output. In this case, ventilating the environment may improve the reduction in light output. Perform a light-up test of the chosen application for optical evaluation to ensure that there are no issues.
- When attaching the LEDs to the heat sink, etc., Nichia recommends using a thermal interface material that has a low thermal resistance (i.e. thermal grease).

### (5) Electrostatic Discharge (ESD)

- This LED is sensitive to transient excessive voltages (e.g. ESD, lightning surge). If this excessive voltage occurs in the circuit, it may cause the LED to be damaged causing issues (e.g. the LED to have a reduction in the radiant flux or not to illuminate [i.e. catastrophic failure]).

Ensure that when handling the LEDs, necessary measures are taken to protect them from an ESD discharge. The following examples are recommended measures to eliminate the charge:

- Grounded wrist strap, ESD footwear, clothes, and floors
  - Grounded workstation equipment and tools
  - ESD table/shelf mat made of conductive materials
  - Ensure that all necessary measures are taken to prevent the LEDs from being exposed to transient excessive voltages (e.g. ESD, lightning surge):
    - tools, jigs, and machines that are used are properly grounded
    - appropriate ESD materials/equipment are used in the work area
    - the system/assembly is designed to provide ESD protection for the LEDs
  - If the tool/equipment used is an insulator (e.g. glass cover, plastic, etc.), ensure that necessary measures have been taken to protect the LED from transient excessive voltages (e.g. ESD). The following examples are recommended measures to eliminate the charge:
    - Dissipating static charge with conductive materials
    - Preventing charge generation with moisture
    - Neutralizing the charge with ionizers
  - To detect if an LED was damaged by transient excess voltages (i.e. an ESD event during the system's assembly process), perform a characteristics inspection (e.g. forward voltage measurement) at low current ( $\leq 4\text{mA}$ ).
  - Failure Criteria:  $V_F < 24.0\text{V}$  at  $I_F = 2.0\text{mA}$
- If the LED is damaged by transient excess voltages (e.g. ESD), it will cause the Forward Voltage ( $V_F$ ) to decrease.

(6) Thermal Management

- When designing, the derating characteristics (i.e. Thermistor Temperature vs. Allowable Forward Current) must be considered. The increase in the temperature of an LED while in operation may vary depending on the heat sink's thermal resistance and the density of LEDs in the system/assembly. Ensure that when using the LEDs for the chosen application, heat is not concentrated in an area and properly managed in the system/assembly to ensure the derating characteristics during actual use.
- Use the thermistor temperature ( $T_{TH}$ ) to determine the operating current for the chosen application and optimize the thermal design (e.g. selecting a proper heat sink, thermal interface material, etc.) accordingly.
- The following two equations can be used to calculate the LED junction temperature:

1)  $T_J = T_{TH} + R_{\theta JTH} \cdot W$       2)  $T_J = T_C + R_{\theta JC} \cdot W$

\* $T_J$ =LED Junction Temperature: °C

$T_{TH}$ =Thermistor Temperature: °C

$T_C$ =Case Temperature(back surface of LED): °C

$R_{\theta JTH}$ =Thermal Resistance from Junction to  $T_{TH}$  Measurement Point: °C/W

$R_{\theta JC}$ =Thermal Resistance from Junction to  $T_C$  Measurement Point: °C/W

$W$ =Input Power( $I_F \times V_F$ ): W

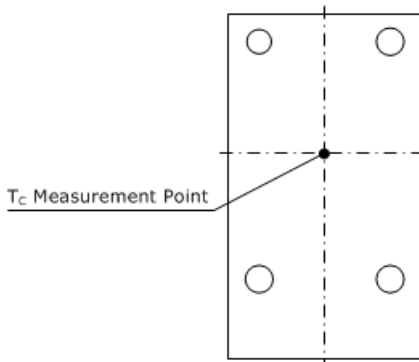

- Once the LEDs have been attached to a heat sink, it is difficult to measure  $T_C$  due to the location of the  $T_C$  measurement point. Refer to the relevant application notes for a method of determining the  $T_J$  by measuring  $T_{TH}$ . **To access the application notes, go to the Technical Suggestions And Recommendations section of Nichia's website.**
- **Refer to the relevant application notes for detailed information (e.g. how to handle the COB LEDs, the effect of adhesion strength between the COB and the heat sink, thermal design considerations, etc.). To access the application notes, go to the Technical Suggestions And Recommendations section of Nichia's website. Note that the application notes may be updated, revised, modified and supplemented without notice.**
- To determine the thermal resistance ( $R_{\theta JTH}$ ), use the following data/equation.

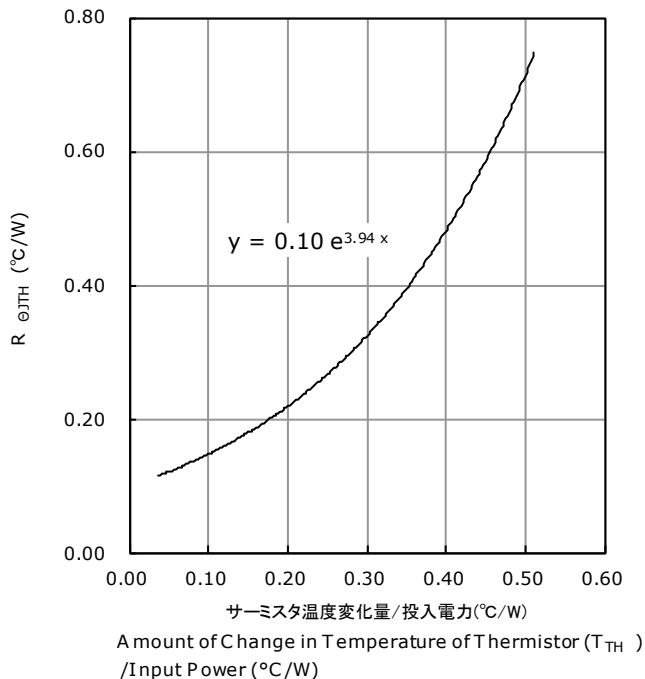

## (7) Cleaning

- Do not wipe/clean the LEDs with any type of material (e.g. dry/wet cloth) or solvent (e.g. benzene, thinner, etc.). Cleaning can cause pressure leading to damage to the top surface (e.g. lens, electrode, connecting device, etc.) that may cause issues (e.g. the LED not to illuminate [i.e. catastrophic failure]).
- If an LED is contaminated (e.g. dust/dirt), use a cloth soaked with isopropyl alcohol (IPA). Ensure that the cloth is firmly squeezed before wiping the LED.

## (8) Eye Safety

- There may be two important international specifications that should be noted for safe use of the LEDs: IEC 62471:2006 Photobiological safety of lamps and lamp systems and IEC 60825-1:2001 (i.e. Edition 1.2) Safety of Laser Products - Part 1: Equipment Classification and Requirements. Ensure that when using the LEDs, there are no issues with the following points:
  - LEDs have been removed from the scope of IEC 60825-1 since IEC 60825-1:2007 (i.e. Edition 2.0) was published. However, depending on the country/region, there are cases where the requirements of the IEC 60825-1:2001 specifications or equivalent must be adhered to.
  - LEDs have been included in the scope of IEC 62471:2006 since the release of the specification in 2006.
  - Most Nichia LEDs will be classified as the Exempt Group or Risk Group 1 according to IEC 62471:2006. However, in the case of high-power LEDs containing blue wavelengths in the emission spectrum, there are LEDs that will be classified as Risk Group 2 depending on the characteristics (e.g. radiation flux, emission spectrum, directivity, etc.)
  - If the LED is used in a manner that produces an increased output or with an optic to collimate the light from the LED, it may cause damage to the human eye.
- If an LED is operated in a manner that emits a flashing light, it may cause health issues (e.g. visual stimuli causing eye discomfort). The system should be designed to ensure that there are no harmful effects on the human body.
- This LED emits light in the ultraviolet (UV) region. The UV light from an LED while in operation is intense and harmful; if human eyes are exposed to this light, it may cause damage to them. Do not look directly or indirectly (e.g. through an optic) at the UV light. Ensure that if there is a possibility that the UV light reflects off objects and enters the eyes, appropriate protection gear (e.g. goggles) is used to prevent the eyes from being exposed to the light.
- Ensure that appropriate warning signs/labels are provided both on each of the systems/applications using the UV LEDs, in all necessary documents (e.g. specification, manual, catalogs, etc.), and on the packaging materials.

## (9) Miscellaneous

- Nichia warrants that the discrete LEDs will meet the requirements/criteria as detailed in the Reliability section within this specification. If the LEDs are used under conditions/environments deviating from or inconsistent with those described in this specification, the resulting damage and/or injuries will not be covered by this warranty.
- Nichia warrants that the discrete LEDs manufactured and/or supplied by Nichia will meet the requirements/criteria as detailed in the Reliability section within this specification; it is the customer's responsibility to perform sufficient verification prior to use to ensure that the lifetime and other quality characteristics required for the intended use are met.
- The applicable warranty period is one year from the date that the LED is delivered. In the case of any incident that appears to be in breach of this warranty, the local Nichia sales representative should be notified to discuss instructions on how to proceed while ensuring that the LED in question is not disassembled or removed from the PCB if it has been attached to the PCB. If a breach of this warranty is proved, Nichia will provide the replacement for the non-conforming LED or an equivalent item at Nichia's discretion. FOREGOING ARE THE EXCLUSIVE REMEDIES AVAILABLE TO THE CUSTOMER IN RESPECT OF THE BREACH OF THE WARRANTY CONTAINED HEREIN, AND IN NO EVENT SHALL NICHIA BE RESPONSIBLE FOR ANY INDIRECT, INCIDENTAL OR CONSEQUENTIAL LOSSES AND/OR EXPENSES (INCLUDING LOSS OF PROFIT) THAT MAY BE SUFFERED BY THE CUSTOMER ARISING OUT OF A BREACH OF THE WARRANTY.
- NICHIA DISCLAIMS ALL OTHER WARRANTIES, EXPRESS OR IMPLIED, INCLUDING THE IMPLIED WARRANTIES OF MERCHANTABILITY AND FITNESS FOR A PARTICULAR PURPOSE.
- This LED is intended to be used for general lighting, household appliances, electronic devices (e.g. mobile communication devices); it is not designed or manufactured for use in applications that require safety critical functions (e.g. aircraft, automobiles, combustion equipment, life support systems, nuclear reactor control system, safety devices, spacecraft, submarine repeaters, traffic control equipment, trains, vessels, etc.). If the LEDs are planned to be used for these applications, unless otherwise detailed in the specification, Nichia will neither guarantee that the LED is fit for that purpose nor be responsible for any resulting property damage, injuries and/or loss of life/health. This LED does not comply with IATF 16949 and is not intended for automotive applications.
- The customer will not reverse engineer, disassemble or otherwise attempt to extract knowledge/design information from the LED.
- All copyrights and other intellectual property rights in this specification in any form are reserved by Nichia or the right holders who have granted Nichia permission to use the content. Without prior written permission from Nichia, no part of this specification may be reproduced in any form or by any means.
- Both the customer and Nichia will agree on the official specifications for the supplied LEDs before any programs are officially launched. Without this agreement in writing (i.e. Customer Specific Specification), changes to the content of this specification may occur without notice (e.g. changes to the foregoing specifications and appearance, discontinuation of the LEDs, etc.).